

Digital Media Player
NW-WM1AM2/NW-WM1ZM2



Model: YY1298B/ YY1299B

Use this manual when you have trouble or when you need to know how to use your player.

The color of the player sold in some countries/regions may differ from those shown above.

The contents of the Help Guide may be subject to change without notice due to updates to the product's specifications.

Getting Started

[Before first use](#)

[Manuals and general information](#)

[Checking the contents of the package](#)

Using the supplied accessories

└ [Using the headphone jack caps](#)

└ [Using the leather case](#)

[Configuring the initial setup](#)

Power and Charging

[Turning the power on](#)

[Turning the power off](#)

[Preventing unintentional operations \(HOLD\)](#)

[Charging the battery](#)

[Extending the battery lifespan](#)

[Reducing the battery consumption](#)

[Notes on charging the battery](#)

microSD Cards

[Using a microSD card](#)

[Notes on microSD cards](#)

Basic Operations

[Parts and controls](#)

Home screen operations

- [\[WALKMAN Home\] screen](#)
- [Android Home screen](#)
- [Displaying the All Apps screen](#)
- [Displaying Quick Settings panel](#)
- [Switching the home screen](#)

Screen operations

- [How to use the various screens of "Music player"](#)
- [Library screen in "Music player"](#)
- [Playback screen in "Music player"](#)
- [Play queue screen in "Music player"](#)
- [Favorites screen in "Music player"](#)
- [Sound adjustment screens for "Music player"](#)

[List of icons displayed in the status bar](#)

[Viewing a guide to enjoy high quality sound](#)

[Setting the screen lock](#)

[Adjusting the volume](#)

[Volume operation in compliance with Directives](#)

Transferring Music

[Preparing music content](#)

[Purchasing High-Resolution Audio content by using a computer](#)

Using a Windows computer

- [Installing Music Center for PC \(Windows\)](#)
 - [Transferring content from a Windows computer using Music Center for PC](#)
 - [Transferring content using Windows Explorer](#)
 - [Importing content from “Music player” to Music Center for PC](#)
-

[Transferring content using Mac computer](#)

[Adding lyric information using a computer](#)

[Notes on transferring content from a computer](#)

Enjoying music services via Wi-Fi connection

[Connecting the player to a Wi-Fi network](#)

Google Account

- [Setting up a Google Account](#)
-

[Purchasing music content from online music services by using the player](#)

[Purchasing High-Resolution Audio content by using the player](#)

[Installing apps to enjoy online music services](#)

[Enjoying the 360 Reality Audio service](#)

[Notes on Wi-Fi connections](#)

[Notes on security when connecting to the internet](#)

Playing, Organizing, or Deleting Music

[Playing music](#)

[Playback methods](#)

Displaying lyrics

- [Obtaining lyric information](#)

[Displaying Lyrics](#)

[Managing playlists in “Music player”](#)

[Importing playlists from a Windows computer, playing, or deleting playlists in “Music player”](#)

[Managing Favorites in “Music player”](#)

[Deleting tracks from “Music player”](#)

Enjoying music with Bluetooth devices

[Connecting the player to an unpaired Bluetooth device for the first time](#)

[Connecting the player to a paired Bluetooth device](#)

[Configuring the Bluetooth function](#)

[Notes on the Bluetooth function](#)

Various Functions

Using the USB-DAC function

[Enjoying music content on a computer using the sound quality of the player \(USB-DAC function\)](#)

[USB-DAC screen in “Music player”](#)

[Adjusting the sound](#)

[Using the High-Res streaming function](#)

[Settings menu in “Music player”](#)

Restarting, formatting, or initializing the player

[Restarting the player](#)

[Formatting the player](#)

[Formatting a microSD card](#)

Various information and system updates

[Checking information on the player](#)

[Updating the system software](#)

Announcement

[Notes on handling the player](#)

[Notes on the headphones](#)

[Notes on the built-in battery.](#)

[Notes on the sample data](#)

[General Information](#)

[Maintenance](#)

[Customer support website](#)

Specifications

[Specifications](#)

[Battery life](#)

[Maximum recordable number of songs](#)

[Supported formats](#)

[System requirements](#)

Digital Media Player
NW-WM1AM2/NW-WM1ZM2

Before first use

Thank you for purchasing a player.

- For information on laws, regulations, and trademark rights, refer to “Important Information” in the internal memory of your unit. To read it, copy the [Important_Information] file to your computer, and follow the steps below. Double-click the [Important_Information] file. Then, select a language. For some languages not listed, equivalent content is provided in print.
- Before you start using the player, read the topics under [Related Topic].
- Google, Android and other marks are trademarks of Google LLC.
- All other trademarks and registered trademarks are trademarks or registered trademarks of their respective holders. In this manual, TM and ® marks are not specified.

Before you start using the player, check the following information.

Model names

Several model names appear in this [Help Guide]. Some models are not available depending on the country or region where you purchased the player.

Computer system requirements

When you connect the player to a computer, check the computer system requirements.

Battery charging

The battery might be low when you use the player for the first time. Charge the battery before use.

microSD cards

The following memory cards are referred to as [microSD cards] in this [Help Guide].

- microSD cards
- microSDHC cards
- microSDXC cards

Images and illustrations

- The screen images and illustrations in this [Help Guide] are for reference only. They may differ from the actual product or onscreen display.
- Unless otherwise specified, the screen images and illustrations in this [Help Guide] depict the NW-WM1AM2.
- Unless otherwise specified, the home screen images in this [Help Guide] are images of the [WALKMAN Home] screen.

Design and specifications are subject to change without notice.

Related Topic

- [Manuals and general information](#)
- [System requirements](#)
- [Charging the battery](#)
- [Notes on handling the player](#)
- [Notes on the headphones](#)
- [Notes on the built-in battery](#)
- [Notes on the sample data](#)
- [General Information](#)
- [Maintenance](#)
- [Customer support website](#)

Digital Media Player
NW-WM1AM2/NW-WM1ZM2

Manuals and general information

Sony provides the following manuals and information regarding the player.
The provided manuals explain the following operations and functions.

Reference Guide (printed)

- Notes on using the player
- Compliance information
- How to access [Important Information]

Operating Instructions (printed)

- Basic steps to start listening to music after you purchase the player.

Help Guide (web manual)

This [Help Guide] provides the standard operating procedures only. You can view the [Help Guide] via the internet. Use a computer, a smartphone, or the player connected to a Wi-Fi network.

- How to transfer content to the player.
- How to use various functions.
- Notes on using the player.

The Help Guide refers to the product as “player.”

Important Information

- Information on copyrights, laws, and regulations
See [Before first use] for details on viewing the information.

Customer support website (online)

See [Customer support website] in this [Help Guide].

- The latest information on the player
- FAQ: Frequently Asked Questions

The contents of the Help Guide may be subject to change without notice due to updates to the product's specifications.

Related Topic

- [Before first use](#)
- [Customer support website](#)

Digital Media Player
NW-WM1AM2/NW-WM1ZM2

Checking the contents of the package

NW-WM1AM2/NW-WM1ZM2 (Common)

- WALKMAN® (1)
- USB Type-C® cable (USB-A to USB-C) (1)
- Operating Instructions
- Reference Guide
- Headphone jack cap (Stereo Mini) (1) (*1)
- Headphone jack cap (Balanced Standard) (1) (*1)

NW-WM1ZM2

- Leather case (1)

*1 The headphone jack caps are attached to the Walkman.

Note

- Headphones and a microSD card are not supplied with the Walkman.
- Models to sell vary by country or region.

The contents of the Help Guide may be subject to change without notice due to updates to the product's specifications.

Related Topic

- [Customer support website](#)

Digital Media Player
NW-WM1AM2/NW-WM1ZM2

Using the headphone jack caps

Headphone jack caps (1, 3) are attached to the headphone jacks (2, 4) at the time of purchase. Attach the caps to the headphone jacks when no headphones are connected to the jacks. Leaving sweat or water droplets on a headphone jack may cause the jack to corrode and result in a malfunction. There is a charge for repairing malfunctions caused by corrosion of the headphone jacks.

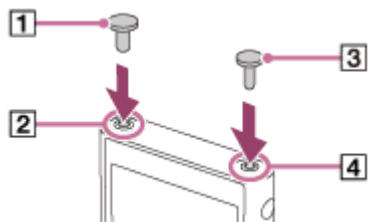

- 1: Headphone jack cap (Balanced Standard)
- 2: Headphone jack (Balanced Standard)
- 3: Headphone jack cap (Stereo Mini)
- 4: Headphone jack (Stereo Mini)

The contents of the Help Guide may be subject to change without notice due to updates to the product's specifications.

Related Topic

- [Checking the contents of the package](#)

Digital Media Player
NW-WM1AM2/NW-WM1ZM2

Using the leather case

(Only for models supplied with a leather case)

Attaching the leather case

1. Insert the player from the top of the leather case. (1)
2. Fold the band over the player and insert it between the player and the leather case. (2)

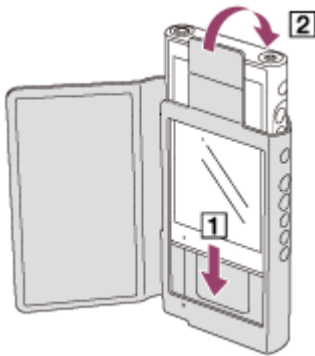

Detaching the leather case

1. Pull out the band. (1)
2. Pull the player up from the leather case. (2)

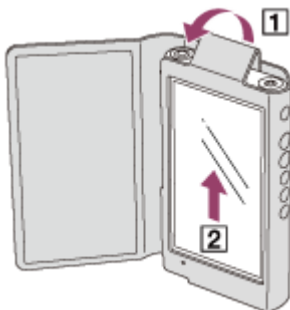

Notes on the genuine leather case

- The leather case is made of natural leather. Unlike artificial leather, natural leather may have scratches, wrinkles, or vein marks on the surface. Each leather case has different characteristics and colors.
- Leather is a soft material. If you wrap the headphone cord around the leather case, it may leave dents or cord marks on the leather case.
- Before you use a cleaner, read the instructions carefully. Try the cleaner on an inconspicuous part first.
- For cleaning, do not use any type of solvent such as alcohol or paint thinner. Such solvents may damage the leather case. For example, they may cause color fading, deformation, or degradation.
- Moisture such as rain or sweat, or friction may cause discoloration or color transference to your clothes, etc.
- Do not use or store the leather case in the following kinds of places.
 - Places where the leather case is exposed to direct sunlight (such as in a car).
 - Places with extremely high/low temperatures.
 - Places with high humidity or dust.

Do not place this product close to medical devices.

This product (including accessories) has magnet(s) which may interfere with pacemakers, programmable shunt valves for hydrocephalus treatment, or other medical devices. Do not place this product close to persons who use such medical devices. Consult your doctor before using this product if you use any such medical device.

The contents of the Help Guide may be subject to change without notice due to updates to the product's specifications.

Related Topic

- [Checking the contents of the package](#)

5-031-748-11(3) Copyright 2022 Sony Corporation

Digital Media Player
NW-WM1AM2/NW-WM1ZM2

Configuring the initial setup

When you turn on the player for the first time, a screen for the initial setup will appear.
The following items can be set as necessary later.

- Wi-Fi setup
- Google™ Account

1 Hold down the (power) button () for 5 seconds until the player turns on.

The player may not turn on if the battery level is low. Charge the player for about 30 minutes.

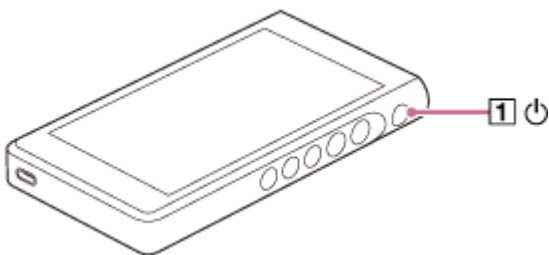

If necessary, select a language and go to the next step.

2 Tap [START].

3 Confirm the content of [End user license agreement], and then tap [AGREE].

4 Follow the onscreen instructions.

5 On the [Select Home screen] menu, select the main home screen and tap [OK].

Whichever home screen you select here will be displayed when you tap the  (home) button.

- [Page 1 (default Home)]: Default Android Home screen
- [Page 2 (WALKMAN® Home)]: Home screen customized for music playback

The [WALKMAN Home] screen features the Music player widget. You can control music playback on the home screen without launching an app. We recommend selecting the [WALKMAN Home] screen as the main home screen.

The [WALKMAN Home] screen appears when the initial setup is complete.

Hint

- You can change the main home screen after the initial setup.
On the home screen, hold down an empty space.
Tap the menu items in the following order.
[Home settings] – [Select Home screen].
Select the desired home screen.

Note

- If you forget the method that you have set for unlocking the screen (PIN, password, pattern, etc.), you will not be able to unlock the screen yourself.
 - Repair requires a fee.
 - All data will be erased because the repair requires reformatting.

Please remember how to unlock the screen.

- If you configure a Wi-Fi connection during the initial setup, you can choose whether or not to transfer apps and data. However, it may take some time to complete the initial setup depending on the amount of data to be transferred. We recommend not transferring apps and data during the initial setup.

Instructional video

There is an instructional video for the following operations.

- Initial setup

Visit the following link.

https://rd1.sony.net/help/dmp/mov0005/h_zz/



The contents of the Help Guide may be subject to change without notice due to updates to the product's specifications.

Related Topic

- [Connecting the player to a Wi-Fi network](#)
- [Setting up a Google Account](#)
- [Charging the battery](#)
- [\[WALKMAN Home\] screen](#)
- [Android Home screen](#)
- [Switching the home screen](#)

Digital Media Player
NW-WM1AM2/NW-WM1ZM2



Turning the power on

- 1 Hold down the  (power) button () for 5 seconds until the player turns on.

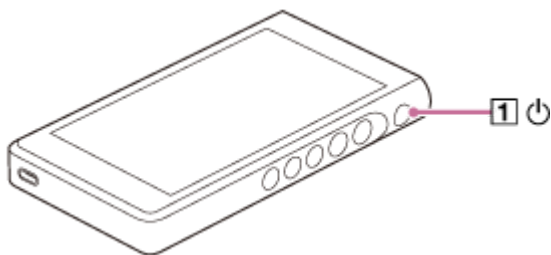
When you turn on the player for the first time, a screen for the initial setup will appear. Follow the onscreen instructions to complete the setup.



Hint

- The screen will turn off automatically if you do not operate the player for a certain period of time. To turn on the screen, press the  (power) button (.
- To conserve the battery power, set [Auto power off]. The player will turn off automatically if you do not operate the player for a certain period of time after you pause playback. Swipe the [WALKMAN Home] screen upwards. Tap the menu items in the following order.
 [Settings] – [Battery] – [Auto power off].

Note

- The player may not turn on if the battery level is low. Charge the player for about 30 minutes.

The contents of the Help Guide may be subject to change without notice due to updates to the product's specifications.

Related Topic

- [Configuring the initial setup](#)
- [Charging the battery](#)
- [Turning the power off](#)

Digital Media Player
NW-WM1AM2/NW-WM1ZM2

Turning the power off

- 1 Hold down the  (power) button () for 2 seconds while the screen is turned on.

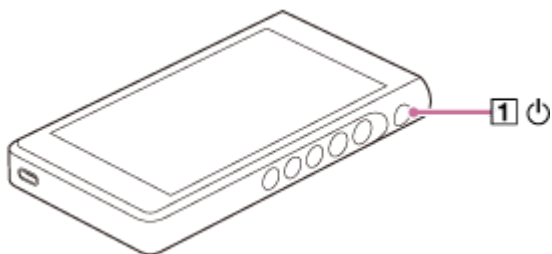

- 2 Tap [Power off].

Hint

- To conserve the battery power, set [Auto power off]. The player will turn off automatically if you do not operate the player for a certain period of time after you pause playback. Swipe the [WALKMAN Home] screen upwards. Tap the menu items in the following order.
 [Settings] – [Battery] – [Auto power off].

The contents of the Help Guide may be subject to change without notice due to updates to the product's specifications.

Related Topic

- [Turning the power on](#)

Digital Media Player
NW-WM1AM2/NW-WM1ZM2

Preventing unintentional operations (HOLD)

You can lock the operating buttons on the player to prevent accidental button operations.

1 Slide the HOLD switch (1) upwards.

The HOLD function is enabled. The status icon (HOLD) will appear in the status bar. You cannot operate the following buttons.

- Playback operating buttons
- +/- (volume) buttons

You can operate the following parts even while you have enabled the HOLD function.

- ⏻ (power) button
- Touch screen

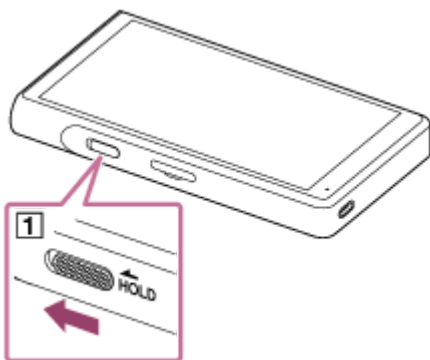

Hint

- Slide the HOLD switch (1) downwards to release the HOLD function.
- When you carry the player, press the ⏻ (power) button to turn off the screen. You can prevent unintentional operations on the touch screen.

The contents of the Help Guide may be subject to change without notice due to updates to the product's specifications.

Related Topic

- [Parts and controls](#)

Digital Media Player
NW-WM1AM2/NW-WM1ZM2

Charging the battery

1 Connect the player to a running computer via USB.

The charge lamp in the bottom left of the screen lights up.
When charging is complete, the charge lamp turns off.



2 Disconnect the player from the computer.

Hint

- For details on how long it takes to charge the battery fully, see [Specifications].

Note

- If charging is insufficient, the computer may not recognize the player. In this case, the screen of the player will not turn on. Charge the player sufficiently. The computer will recognize the player after about 30 minutes of charging.

The contents of the Help Guide may be subject to change without notice due to updates to the product's specifications.

Related Topic

- [Reducing the battery consumption](#)
- [Notes on charging the battery](#)
- [Specifications](#)

Digital Media Player
NW-WM1AM2/NW-WM1ZM2

Extending the battery lifespan

The [Battery Care] function reduces deterioration in the battery's performance by limiting the maximum charging capacity of the battery.

1 Swipe the [WALKMAN Home] screen upwards.

2 Tap the menu items in the following order.
 [Settings] – [Battery] – [Battery Care].

3 Tap the switch to turn the function on.

 will appear in the status bar.

Note

- When the function is turned on, the maximum charging capacity is limited, and the battery will not fully charge. This is not a malfunction.
- While the function is turned on,  will appear in the status bar even when the battery is not charging.

The contents of the Help Guide may be subject to change without notice due to updates to the product's specifications.

Related Topic

- [Charging the battery](#)

Digital Media Player
NW-WM1AM2/NW-WM1ZM2

Reducing the battery consumption

You can reduce the battery consumption by using the player in the following manner.

The battery life depends on usage conditions. For details on the battery life, see [Battery life].

- Turn off the power manually when you do not use the player.
- Turn off apps when you are not using them.
- Set [Auto power off]. The player will turn off automatically if you do not operate the player for a certain period of time after you pause playback.
Swipe the [WALKMAN Home] screen upwards. Tap the menu items in the following order.
 [Settings] – [Battery] – [Auto power off].
- Adjust the screen brightness.
- Turn off all sound adjustments.
- Turn off the Bluetooth function when you are not using it.
- Turn off the Wi-Fi function when you are not using it.

The contents of the Help Guide may be subject to change without notice due to updates to the product's specifications.

Related Topic

- [Charging the battery](#)
- [Turning the power off](#)
- [Sound adjustment screens for "Music player"](#)
- [Connecting the player to a Wi-Fi network](#)
- [Notes on the built-in battery](#)
- [Displaying lyrics](#)
- [Battery life](#)

Notes on charging the battery

- Always use the supplied USB Type-C cable.
- Firmly insert the USB Type-C cable all the way in. Charging will not start until you insert the USB Type-C cable completely.
- The charging time depends on the battery usage conditions.
- When the battery is sufficiently charged but the battery life has dropped to about half of its normal span, the battery may be worn out. Contact the nearest Sony dealer or Sony Service Center.
- The computer may not recognize the player in the following situations.
 - When you connect the player to the computer for the first time
 - When the player has not been used for a long period of time
Charge the player for about 30 minutes. The player may start operating normally.
- Charge the battery at an ambient temperature from 5 °C to 35 °C (41 °F to 95 °F).
When the ambient temperature exceeds the recommended range,  appears on the status bar and then charging is forcibly terminated. Even when the environment is within the recommended temperature range, the internal temperature of the player may become too hot. In this case, you may be unable to fully charge the battery.
- The battery can be recharged about 500 times from a completely depleted state. The exact number of times may vary depending on the usage conditions.
- To prevent deterioration of the battery, charge the battery at least once every 6 months.
- Charging is not guaranteed when you use a homebuilt or modified computer.
- Charging from a USB hub is only guaranteed when you use a self-powered USB hub that carries an authorized logo.
- Even if the player is connected to a computer, the player cannot charge in the following situations.
 - When the computer is in sleep mode.
Wake the computer before you connect the player.
 - When you are not using the supplied USB Type-C cable.
Use the supplied USB Type-C cable.
 - When the player is connected via a USB hub.
Connect the player directly to the USB port of your computer.
- When you connect the player to a computer for a long period of time, connect the computer to an AC power supply. Otherwise, the computer's battery may run out.
- While the player is connected to a computer, observe the following cautions. Otherwise, the player may not function properly.
 - Do not turn on the computer.
 - Do not restart the computer.
 - Do not wake the computer from sleep mode.
 - Do not shut down the computer.

- The player may become hot during usage conditions such as charging, or charging and using an app at the same time. This is not a malfunction.
- When the Battery Care function is turned on, the maximum charging capacity is limited, and the battery will not fully charge. This is not a malfunction.
- The battery indicator does not correspond exactly to the remaining battery level. Refer to the battery indicator as a guide.
- When you charge the player using a computer, do not remove the USB Type-C cable while data is transferring. If you disconnect the USB Type-C cable, data on the player may be lost.

The contents of the Help Guide may be subject to change without notice due to updates to the product's specifications.

Related Topic

- [Charging the battery](#)
- [Extending the battery lifespan](#)
- [Reducing the battery consumption](#)
- [Notes on the built-in battery](#)
- [Battery life](#)

5-031-748-11(3) Copyright 2022 Sony Corporation

Digital Media Player
NW-WM1AM2/NW-WM1ZM2

Using a microSD card

This topic includes instructions for the following operations.

- Inserting a microSD card into the player.
- Formatting a microSD card on the player.
To use a microSD card on the player, you first need to format the microSD card on the player.
- Removing a microSD card from the player.

1 Insert a microSD card.

Hook your fingernail in the notch (1) of the microSD card slot to release the lock.
Grasp the microSD card tray (2) and pull the tray straight out.

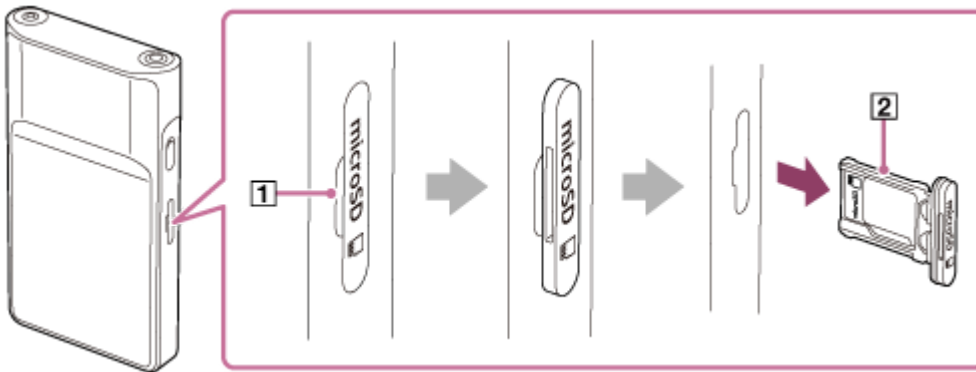

Set a microSD card inside the microSD card tray (2) in the correct direction.

The gold contact pins should face the back side of the player.

Make sure to insert the microSD card correctly. Otherwise, the microSD card will fall out when you hold the tray (2) upside down.

Insert the tray (2) straight into the card slot (3).

Be sure to insert the tray firmly into the slot with no gaps.

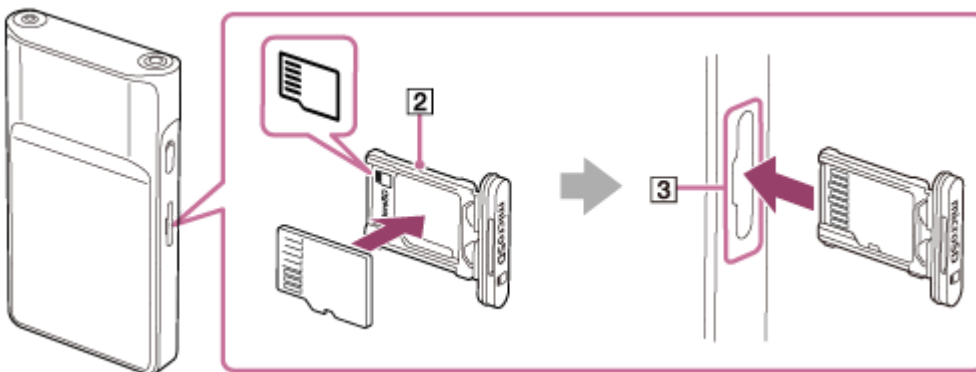

2 Format the microSD card.

Swipe the [WALKMAN Home] screen upwards.

Tap the menu items in the following order.

⚙️ [Settings] – [Storage].

Tap the name of the microSD card.

Tap the menu items in the following order.

⋮ (options) – [Storage settings] – [Format].

Follow the onscreen instructions to complete formatting.

To remove the microSD card

Before you remove a microSD card from the player, first unmount the microSD card from the player.

1. Swipe the [WALKMAN Home] screen upwards.
2. Tap the menu items in the following order.
⚙️ [Settings] – [Storage].
3. Tap the eject icon to the right side of the microSD card name.
4. Hook your fingernail in the notch of the microSD card slot.
Pull the microSD card tray straight out.
Remove the microSD card.

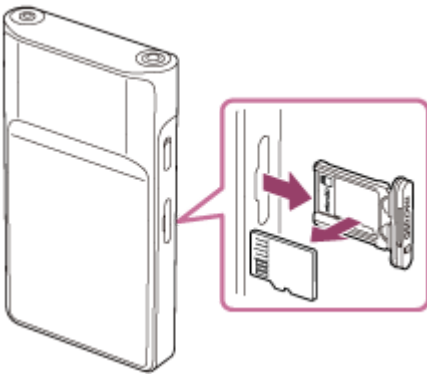

5. Insert the tray straight into the card slot.
Be sure to insert the tray firmly into the slot with no gaps.

Note

- When you handle the microSD card tray, ensure that the direction is correct. Also, make sure to move the tray straight and gently. Excessive force may cause damage or deformation.
- If the player does not recognize the microSD card, remove and reinsert the microSD card tray into the player.
- Do not insert any object other than a microSD card tray into the microSD card slot.
- If the inserted microSD card contains a large amount of data, it may take about 10 minutes or longer for “Music player” to build the database.
- When you remove the microSD card, the following information will be deleted.
 - The content that is currently being played.
 - The playback position.
 - Tracks and the playback order on the play queue screen.
- When you remove the microSD card, the following information will disappear.
 - Favorite information for tracks/albums/playlists stored on the microSD card.
 - Playlist registration information for tracks stored on the microSD card.
- Formatting a microSD card will delete all data stored on the microSD card. Save a backup of important data.

Related Topic

- [Notes on microSD cards](#)
- [Formatting a microSD card](#)

5-031-748-11(3) Copyright 2022 Sony Corporation

Notes on microSD cards

- Use a microSD card that has been formatted on the player. Sony does not guarantee the operation of other microSD cards.
- Sony does not guarantee all operations for microSD cards that are used on multiple devices.
- Formatting a microSD card will delete all data stored on the microSD card. Save a backup copy in advance.
- Do not leave a microSD card within the reach of small children. Small children may accidentally swallow the microSD card.
- The microSD card may become damaged in the following situations.
 - When the microSD card is removed without unmounting.
 - When the microSD card is removed during a transfer/playback/formatting operation.
- Sony does not guarantee the operation of all types of compatible microSD cards with the player.
- Data may be corrupted in the following situations.
 - When a microSD card is removed during a read or write operation.
 - When the player is turned off during a read or write operation.
 - When a microSD card is used in a location where there is static electricity or electrical noise.
- Sony assumes no responsibility for any loss or damage of stored data. Sony recommends that you save a backup copy of important data regularly.
- Observe the following cautions when you handle microSD cards.
 - Do not apply strong force to a microSD card.
 - Do not bend a microSD card.
 - Do not drop a microSD card.
 - Do not disassemble a microSD card.
 - Do not modify a microSD card.
 - Do not expose a microSD card to water.
 - Do not leave a microSD card in the hot interior of a car.
 - Do not leave a microSD card in direct sunlight.
 - Do not leave a microSD card near a heater.
 - Do not leave a microSD card in a humid place.
 - Do not leave a microSD card in a location where corrosive substances are present.
 - Do not attach labels.
 - Do not touch contact pins of a microSD card with your hands or metal.
- Observe the following cautions regarding the microSD card tray and the microSD card slot.
 - Insert the microSD card tray straight in the correct direction.
 - Do not insert any object other than the microSD card tray into the microSD card slot.

The contents of the Help Guide may be subject to change without notice due to updates to the product's specifications.

Related Topic

- [Using a microSD card](#)
- [Formatting a microSD card](#)

5-031-748-11(3) Copyright 2022 Sony Corporation

Parts and controls

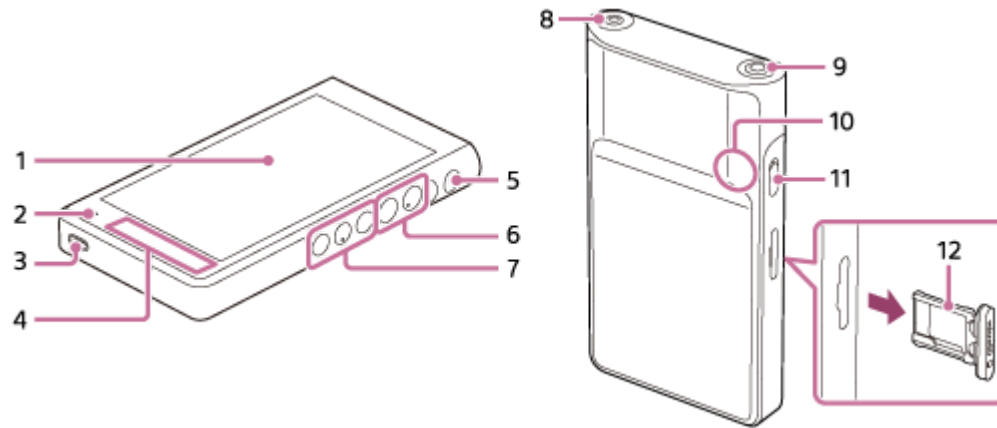

1. Touch screen
Tap icons or items on the screen to operate the player.
2. Charge lamp
The lamp lights up while the player is charging.
3. USB Type-C port
Connect the player to a running computer with the supplied USB Type-C cable. You can charge the player or enjoy the music on a computer with the USB-DAC function.
4. Built-in antenna
The Wi-Fi antenna and Bluetooth antenna are built in. Do not cover the antennas while you use them.
5. ⏻ (power) button
 - Press the button to turn the screen on or off.
 - Hold down the button for 5 seconds to turn on the player.
 - Hold down the button for 2 seconds to turn off or restart the player.
 - If operations become unstable, hold down the button for 10 seconds to force the player to restart.
6. +(*1)/- (volume) buttons
Press the buttons to adjust the volume.
7. Playback operating buttons
 - ▶|| (play/pause) (*1): Press the button to start or pause playback.
 - ◀◀ (previous track)/▶▶ (next track): Press the buttons to jump to the beginning of the current track, previous track, or next track.
 - Hold down the buttons to fast-rewind or to fast-forward playback.
8. Headphone jack (Stereo Mini) (*2)
Connect headphones with a stereo mini plug. Push in the headphone plug until it clicks into place. Connect the headphones properly. Otherwise, the output sound will be impaired.
9. Headphone jack (Balanced Standard) (*2)
 - Connect headphones with a balanced standard plug. Push in the headphone plug until it clicks into place. Connect the headphones properly. Otherwise, the output sound will be impaired.

- Connect passive headphones (*3) to the headphone jack (Balanced Standard) only. If you use an audio cable to connect the headphone jack (Balanced Standard) to the line-in jack of an audio device, it may damage the device.

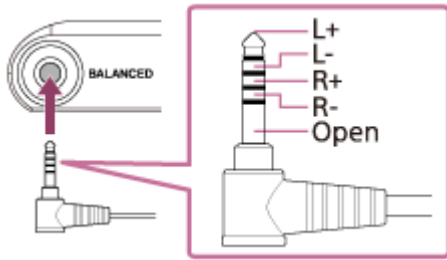

10. Built-in microphone

You can use the built-in microphone to input sound. Do not cover the microphone while you use it.

11. HOLD (hold) switch

Slide the switch to lock the playback operating buttons and +/– (volume) buttons on the player. You can avoid operating the buttons accidentally.

- Locked (inoperable)



- Released (operable)



12. microSD card tray

Hook your fingernail in the notch and pull the tray straight out. Set a microSD card (not supplied) inside the tray.

- *1 There are tactile dots on the ►|| (play/pause) button and the volume + button. The tactile dots can help you operate the buttons without looking at them.
- *2 When headphones are connected to both headphone jacks (Stereo Mini and Balanced Standard), output from one headphone jack (Balanced Standard) will be prioritized.
- *3 Passive headphones: Headphones without a Noise canceling function or Bluetooth function.

The contents of the Help Guide may be subject to change without notice due to updates to the product's specifications.

Digital Media Player
NW-WM1AM2/NW-WM1ZM2

[WALKMAN Home] screen

The [WALKMAN Home] screen is a home screen customized for music playback. It features the Music player widget so that you can control music playback without launching an app. Also, the apps related to music are displayed.

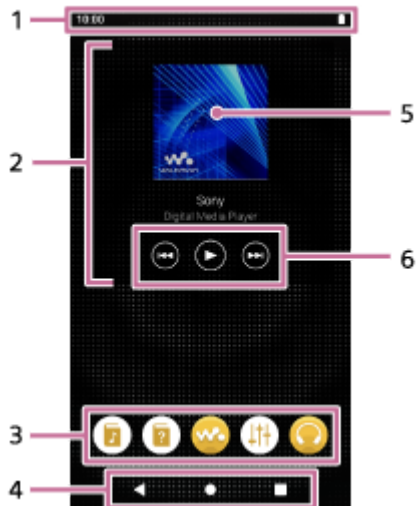

1. Status bar

The status of the player and notifications appear as icons.

Swipe down on the status bar to display the notification panel and the Quick Settings panel.

2. Music player widget

The widget shows the current track of “Music player”.

3. Dock

You can add up to 5 shortcuts for apps.

4. Navigation bar

The navigation bar contains the following 3 buttons. Tap to operate them.

- ◀ **(back) button**
Tap the button to return to the previous screen.
- ● **(home) button**
Tap the button to display the [WALKMAN Home] screen.
- ■ **(overview) button**
Tap the button to display recently used apps.

5. Cover art





Tap the area to launch “Music player”.

6. Previous button / Play (Pause) button / Next button

Tap the buttons to control music playback without launching an app.

Preinstalled apps

Apps such as the following are preinstalled on the player.

-  **[Guide to quality sound]**
Use the app to view information on enjoying content in high sound quality.
-  **[Help Guide]**
Use the app to view [Help Guide].
-  **[Music player]**
Use the app to play music content stored on the player. Prepare music content in the following ways.
 - Transferring music content from your computer to the player.
 - Purchasing music content from online music services.
-  **[Sound adjustment]**
Use the app to adjust the sound. You can directly adjust the sound for the player. This is useful when you play content using apps other than “Music player”.
-  **[Sony | Headphones Connect]**
Use the app to register and set up your headphones.

Hint

- If you select [Page 2 (WALKMAN® Home)] for [Select Home screen] during the initial setup, the [WALKMAN Home] screen will appear when you tap the  (home) button.
- You can change the main home screen after the initial setup.
On the home screen, hold down an empty space.
Tap the menu items in the following order.
[Home settings] – [Select Home screen].
Select the desired home screen.

Note

- Please note that Sony does not accept responsibility for any problems due to apps or services from other companies. Check the terms of service from each provider before use.

The contents of the Help Guide may be subject to change without notice due to updates to the product's specifications.

Related Topic

- [List of icons displayed in the status bar](#)
- [Installing apps to enjoy online music services](#)
- [Switching the home screen](#)

Digital Media Player
NW-WM1AM2/NW-WM1ZM2

Android Home screen

Widgets, shortcuts, folders, and more are displayed on the Android Home screen.

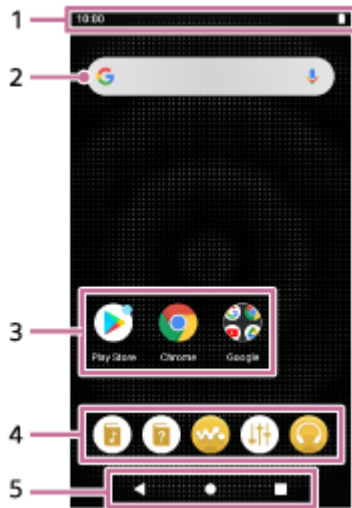

1. Status bar

The status of the player and notifications appear as icons.

Swipe down on the status bar to display the notification panel and the Quick Settings panel.

2. Google search widget

Tap the input field to show the keyboard. Enter text to search on Google.

3. Shortcuts to apps

Tap a shortcut to launch an app.

4. Dock

You can add up to 5 shortcuts for apps.

5. Navigation bar







The navigation bar contains the following 3 buttons. Tap to operate them.

- ◀ **(back) button**
Tap the button to return to the previous screen.
- ● **(home) button**
Tap the button to display the [WALKMAN Home] screen.
- ■ **(overview) button**
Tap the button to display recently used apps.

Preinstalled apps

Apps such as the following are preinstalled on the player.

- 📖 **[Guide to quality sound]**
Use the app to view information on enjoying content in high sound quality.

-  **[Help Guide]**
Use the app to view [Help Guide].
-  **[Music player]**
Use the app to play music content stored on the player. Prepare music content in the following ways.
 - Transferring music content from your computer to the player.
 - Purchasing music content from online music services.
-  **[Sound adjustment]**
Use the app to adjust the sound. You can directly adjust the sound for the player. This is useful when you play content using apps other than “Music player”.
-  **[Sony | Headphones Connect]**
Use the app to register and set up your headphones.
-  **[Play Store]**
Use the app to purchase and/or download various apps from Google Play Store.
-  **[Chrome]**
Use the app to launch Google Chrome and view websites.

Note

- Please note that Sony does not accept responsibility for any problems due to apps or services from other companies. Check the terms of service from each provider before use.

The contents of the Help Guide may be subject to change without notice due to updates to the product's specifications.

Related Topic

- [List of icons displayed in the status bar](#)
- [Installing apps to enjoy online music services](#)
- [Switching the home screen](#)

Digital Media Player
NW-WM1AM2/NW-WM1ZM2

Displaying the All Apps screen

The All Apps screen shows all apps installed on the player. Find the desired app and launch it.

1 **Swipe the [WALKMAN Home] screen upwards.**

The All Apps screen will appear.

Scroll up or down on the screen to find the desired app. Tap the app icon to launch the app.

Hint

- You can display the All Apps screen with the same operation on both the [WALKMAN Home] screen and the Android Home screen.
- You can search for the desired app. Enter the name of the app in the input field at the top of the All Apps screen.

The contents of the Help Guide may be subject to change without notice due to updates to the product's specifications.

Digital Media Player
NW-WM1AM2/NW-WM1ZM2

Displaying Quick Settings panel

The Quick Settings panel allows you to quickly access various functions. You can turn the functions on or off, or adjust the settings.

- 1 On the [WALKMAN Home] screen, swipe down on the status bar twice. Alternatively, swipe down on the status bar with 2 fingers.**

The Quick Settings panel will appear.

The following are some of the functions on the Quick Settings panel at the time of purchase.

- Wi-Fi function
- Bluetooth function
- Volume

- 2 Tap the desired icon to switch the function on or off.**

When you tap the volume icon, the volume dialog appears.

Depending on the function, the setting screen opens when you hold down the icon.

The contents of the Help Guide may be subject to change without notice due to updates to the product's specifications.

Related Topic

- [\[WALKMAN Home\] screen](#)
- [Android Home screen](#)

Digital Media Player
NW-WM1AM2/NW-WM1ZM2

Switching the home screen

This player has two home screens.

- Android Home screen: Default Android Home screen
- [WALKMAN Home] screen: Home screen customized for music playback

Set either of the two home screens as the main home screen. The main home screen appears when you tap the ● (home) button. The [WALKMAN Home] screen features the Music player widget so that you can control music playback without launching an app. We recommend setting the [WALKMAN Home] screen as the main home screen. You can also switch between the two home screens at any time.

Set the main home screen

1. On the home screen, hold down an empty space.
2. Tap [Home settings] – [Select Home screen].
3. Select the desired home screen, and then tap [OK].

Hint

- If you select [Page 2 (WALKMAN® Home)] for [Select Home screen] during the initial setup, the [WALKMAN Home] screen will be set as the main home screen.

Switch the home screen

1. Swipe the home screen to the left or right.

The contents of the Help Guide may be subject to change without notice due to updates to the product's specifications.

Related Topic

- [Configuring the initial setup](#)
- [\[WALKMAN Home\] screen](#)
- [Android Home screen](#)

Digital Media Player
NW-WM1AM2/NW-WM1ZM2

How to use the various screens of “Music player”

“Music player” is a music app preinstalled on the player.
Enjoy listening to the following music content.



- The music content purchased from online music services by connecting the player to a Wi-Fi network.
- The music content transferred from a computer to the player.
- The music content stored on a computer (USB-DAC function).

You can also adjust the sound to suit your preferences.

To launch “Music player”

On the [WALKMAN Home] screen, tap  [Music player].

You can also launch “Music player” by tapping the cover art in the Music player widget.

This topic explains the layout of the various screens of “Music player” with the playback screen () at the center. Swipe the playback screen () to switch to other screens (upwards/downwards/to the left/to the right).

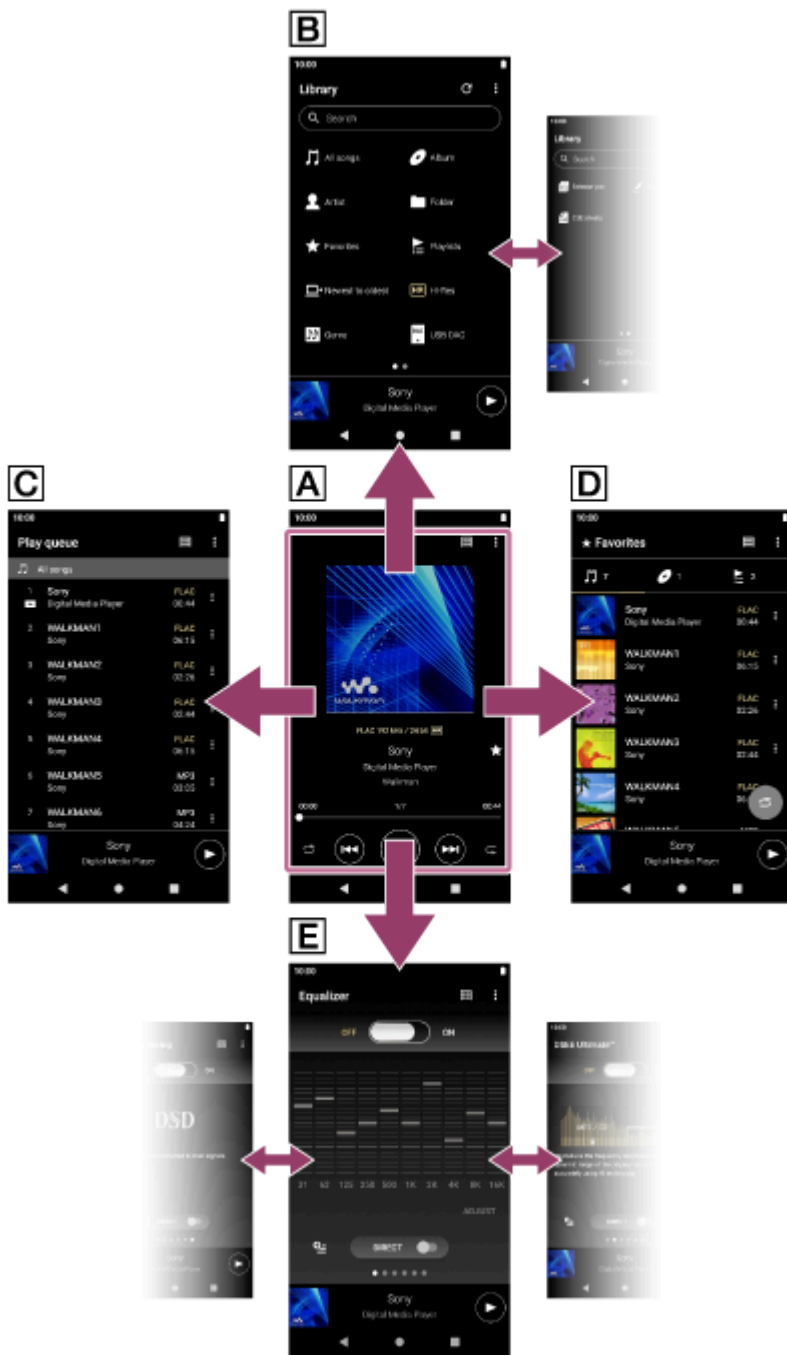

A Playback screen

You can confirm a variety of information for the currently selected track.

B Library screen

You can select tracks from the library screen. Tracks are classified into various categories (such as [All songs], [Album], [Artist], etc.).

C Play queue screen

You can check and edit the list of tracks that the player will play.

D Favorites screen

You can check the tracks/albums/playlists that you have added to Favorites beforehand. The following operations can be performed from this screen.

- Playing tracks/albums/playlists in Favorites.
- Removing tracks/albums/playlists from Favorites.
- Changing the display order of tracks/albums/playlists in Favorites.
- Adding tracks/albums/playlists in Favorites to a playlist or the play queue.

E Sound adjustment screens

You can use the various sound adjustments.

You can save up to 10 customized sound adjustments as [Saved sound settings].

- Equalizer
- DSEE Ultimate™
- DC Phase Linearizer
- Dynamic Normalizer
- Vinyl Processor
- DSD Remastering

Hint

- You can also check how to switch the screen in the operating guide.
On the playback screen, tap the menu items in the following order.
⋮ (Options) – [Operation guide].
- You can also check the operating guide from the library screen or the sound adjustment screens.
Tap the menu items in the following order.
⋮ (Options) – [Operation guide].

Mini player

The mini player appears at the bottom of each screen (except for the playback screen). Tap the mini player to display the playback screen.



1. Current playback position
The area indicates the playback position within the current track.
2. Cover art/Track title/Artist name
Tap the area to display the playback screen. Swipe the area to the left or right to jump to the beginning of the previous track or next track.
3. **▶** (Play)/**⏸** (Pause) button
Tap the **▶** (Play) button to start playback.
Tap the **⏸** (Pause) button during playback to pause playback.

Related Topic

- [Library screen in “Music player”](#)
- [Playback screen in “Music player”](#)
- [Play queue screen in “Music player”](#)
- [Favorites screen in “Music player”](#)
- [Sound adjustment screens for “Music player”](#)
- [Enjoying music content on a computer using the sound quality of the player \(USB-DAC function\)](#)

5-031-748-11(3) Copyright 2022 Sony Corporation

Library screen in “Music player”

You can select tracks from the library screen. Tracks are classified into various categories (such as [All songs], [Album], [Artist], etc.).

To display the library screen

Swipe the playback screen in “Music player” downwards. Alternatively, tap  (Library top) button in the top right of the screen.

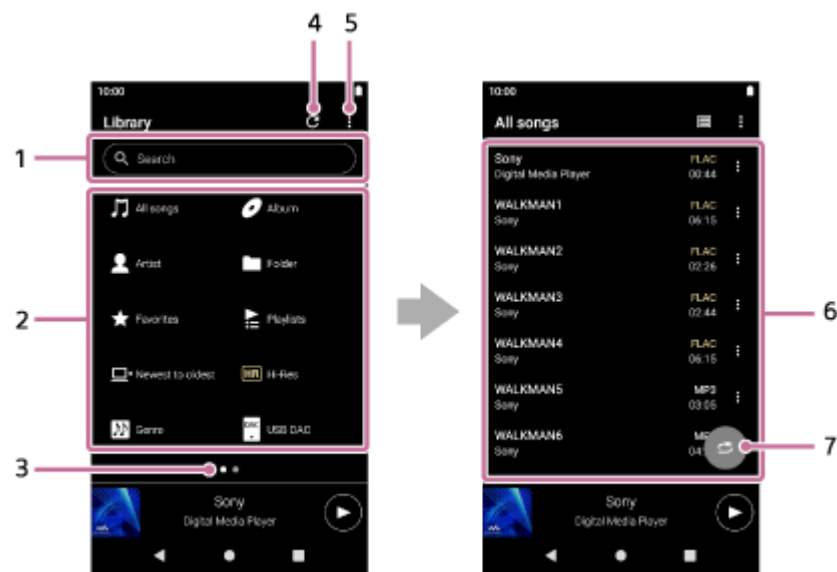

1. Search area

Tap the area to display the keyboard and input text. Type keywords to search for items such as track titles.

2. Music categories ([All songs], [Album], [Artist], etc.)

Each track is classified into several categories. Select a track from the desired category.

- Tap [Hi-Res] to search tracks by the quality of sound with one of the following filters.
 - [Hi-Res]
 - [CD quality]
 - [Compressed]
- Connect the player to a computer and tap [USB DAC] to enjoy the music stored on the computer with the same sound quality as the player.

3. Page indicator

The number of dots represents the number of available pages. Swipe the screen to the left or right to switch to a different page.

4. Update database button

Tap the button to update the database of “Music player”.

A purchased content or a transferred content may not appear in the library of “Music player”. In this case, ensure that the music file is in the [Music] or the [Download] folder in the memory of the player, or in the [Music] folder on the microSD card. Also, update the database.

5. Options button

6. Subcategories or track list

After you select a music category, select a subcategory until you find the desired track.

You can check the codecs for tracks, such as FLAC. Codecs for High-Resolution Audio formats appear in color.

7. Shuffle playback button

Tap to start shuffle playback with the displayed track list as the playback range.

Option menu

Tap  (Options) to display the option menu.

Displayed items may differ depending on the screen or settings.

Settings

Select the item to display the Settings menu for "Music player".

Select items to display

Select the item to set which categories to display or not to display.

Reset display item settings

Select the item to display the default categories.

Operation guide

Select the item to view the operating guide.

Create new playlist

Select the item to create a new playlist.

Delete all playlists

Select the item to delete all playlists.

Edit song order

Select the item to change the order of tracks in the playlist.

Edit Favorites order

Select the item to change the order of items in Favorites.

Remove all

Select the item to remove all tracks or all items from the playlist or Favorites.

Rename playlist

Select the item to change the name of the playlist.

Add to playlist

Select the item to add all tracks in the selected item to a playlist.

Play next

Select the item to add all tracks in Favorites to the position after the current track in the play queue.

Add to the end of Play queue

Select the item to add all tracks in Favorites to the end of the play queue.

Empty Play queue and add

Select the item to clear the current play queue and newly add all tracks in Favorites to the play queue.

Context menu

Tap  (Context menu) to display the context menu.  (Context menu) appears to the right side of each item in a subcategory list.

Displayed items may differ depending on the screen or settings.

Add to Favorites

Select the item to add the selected track/album/playlist to Favorites.

Add to playlist

Select the item to add the selected track or all tracks in the selected item to a playlist.

Add to another playlist

Select the item to add all tracks in the selected playlist to another playlist.

Play next

Select the item to add the selected track or all tracks in the selected item to the position after the current track in the play queue.

Add to the end of Play queue

Select the item to add the selected track or all tracks in the selected item to the end of the play queue.

Empty Play queue and add

Select the item to clear the current play queue and newly add the selected track or all tracks in the selected item to the play queue.

Remove from this list

Select the item to remove the selected item from the playlist or Favorites.

Rename playlist

Select the item to change the name of the playlist.

Detailed song information

Select the item to display the details of the track.

Delete

Select the item to delete the selected track, playlist, or folder.

Hint

- You can move the category icons. Hold down an icon, and drag-and-drop it to the preferred position.
- You can also display the context menu by holding down an item in the list.
- You can also update the database from the Settings menu for “Music player”.
Tap the menu items in the following order.
☰ (Options) – [Settings] – [Update database].
- When [Add to playlist] or [Add to another playlist] is selected, a playlist transferred from a computer cannot be selected as the addition destination. In this case, create a new playlist with the same content as the playlist transferred from the computer in advance, and then select that playlist as the addition destination.
On the library screen, tap ☰ (Context menu) to the right side of the playlist transferred from the computer.
Tap the menu items in the following order.
[Add to another playlist] – [Create new playlist].

The contents of the Help Guide may be subject to change without notice due to updates to the product's specifications.

Related Topic

- [How to use the various screens of “Music player”](#)
- [Playing music](#)
- [Play queue screen in “Music player”](#)
- [Managing playlists in “Music player”](#)
- [Importing playlists from a Windows computer, playing, or deleting playlists in “Music player”](#)
- [Managing Favorites in “Music player”](#)
- [USB-DAC screen in “Music player”](#)

Digital Media Player
NW-WM1AM2/NW-WM1ZM2

Playback screen in “Music player”

You can confirm a variety of information for the currently selected track. During playback, the background color of the screen changes to match the base color of the cover art.

To display the playback screen

On the [WALKMAN Home] screen, tap  [Music player].

You can also launch “Music player” by tapping the cover art of Music player widget.

If a screen other than the playback screen appears, perform one of the following procedures.

- Swipe the screen (upwards/downwards/to the left/to the right).
- Tap the mini player to display the playback screen.

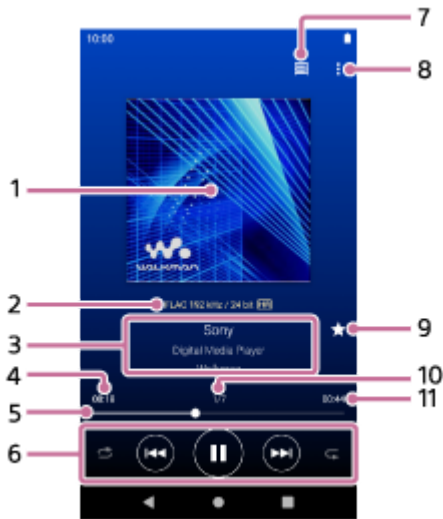

1. Cover art
2. Sound quality (codec, sampling frequency, bit rate/quantization bit rate) / High-Resolution Audio icon
3. Track title / Artist name / Album title
4. Elapsed time of the current track
5. Timeline bar
6. Shuffle button / Previous button / Play (Pause) button / Next button / Repeat button
7. Library top button
8. Options button
9. Favorites button
Tap this button to add the current track to Favorites, or to remove the track from Favorites.
10. Track number / Total number of tracks
11. Length of the track

Option menu

Tap  (Options) to display the option menu.
Displayed items may differ depending on the settings.

Settings

Select the item to display the Settings menu for “Music player”.

Add to playlist

Select the item to add the current track to a playlist.

Search related

Select the item to search for content related to the current track, such as tracks on the same album and albums from the same artist.

Display tape playback screen

When you turn on the item, the playback screen changes to an animation of a cassette tape rotating. The type of cassette tape displayed varies according to the track being played back.

Detailed song information

Select the item to display the details of the current track.

Display lyrics

Select the item to display the lyrics of the current track.



Delete

Select the item to delete the current track.

Operation guide

Select the item to view the operating guide.

Hint

- You can determine the current status of playback from the background color of the playback screen.
 - During playback: the base color of the cover art
 - Paused: black
- Drag the timeline bar to change the playback position within a track.
While you drag the timeline bar, the elapsed time of the current track appears over the cover art.
- If a certain amount of time elapses without any button or screen operations on the playback screen, the display will switch to the cassette tape screen. This occurs when you select the playback screen while there is a check mark in the box for [Display tape playback screen]. To perform screen operations, tap the cassette tape screen. The display will temporarily switch back to the regular playback screen. Then, you can perform screen operations.
- Even if there is a check mark in the box for [Display tape playback screen], the playback screen will not switch to the cassette tape screen while the item [Detailed song information] or [Display lyrics] is displayed.
- You can also turn the [Display tape playback screen] function on or off from the menu of any screen in “Music player”. Tap the menu items in the following order.
 (Options) – [Settings] – [Play on cassette tape screen].
- You can also execute [Search related] by tapping the track title, artist name, or album title on the playback screen in “Music player”.
- When [Add to playlist] is selected, a playlist transferred from a computer cannot be selected as the addition destination. In this case, create a new playlist with the same content as the playlist transferred from the computer in advance, and then select that playlist as the addition destination.
On the library screen, tap  (Context menu) to the right side of the playlist transferred from the computer.
Tap the menu items in the following order.
[Add to another playlist] – [Create new playlist].

Note

- The player will automatically turn off the screen if you have displayed the tape playback screen for 10 minutes.
- The elapsed time and timeline bar indications may not be accurate.
- The player may not display cover art depending on the file format.

The contents of the Help Guide may be subject to change without notice due to updates to the product's specifications.

Related Topic

- [How to use the various screens of "Music player"](#)
- [Playing music](#)
- [Playback methods](#)
- [Managing playlists in "Music player"](#)
- [Importing playlists from a Windows computer, playing, or deleting playlists in "Music player"](#)
- [Managing Favorites in "Music player"](#)
- [Displaying lyrics](#)

5-031-748-11(3) Copyright 2022 Sony Corporation

Digital Media Player
 NW-WM1AM2/NW-WM1ZM2

Play queue screen in “Music player”

You can check and edit the list of tracks that the player will play.

To display the play queue screen

Swipe the playback screen in “Music player” to the right.



1. Playback unit
2. Current track
3. Playback order
4. Library top button
5. Options button
6. Context menu button
7. Content list
 - Artist name
 - Track title
 - Codec
 Codecs for High-Resolution Audio formats appear in color.
 - Length
8. Scroll indicator

Option menu

Tap  (Options) to display the option menu.
 Displayed items may differ depending on the settings.

Settings

Select the item to display the Settings menu for “Music player”.

Edit song order

Select the item to change the order of tracks in the current play queue. Drag and drop the reordering icons on the left sides of the tracks until they are in the desired order.

Add to playlist

Select the item to add all tracks in the current play queue to a playlist.

Context menu

Tap  (Context menu) to display the context menu.  (Context menu) will appear to the right side of each item. Displayed items may differ depending on the settings.

Add to Favorites

Select the item to add the track to Favorites.

Add to playlist

Select the item to add the track to a playlist.



Remove from this list

Select the item to remove the track from the current play queue.

Detailed song information

Select the item to display the details of the track.

Hint

- You can also display the context menu by holding down an item in the list.
- You can add items such as tracks/albums/playlists to the play queue.
On the library screen or favorites screen, tap  (Context menu) to the right side of the item, and then tap one of the following items.
 - [Play next]
Select the item to add the selected track or all tracks in the selected item to the position after the current track in the play queue.
 - [Add to the end of Play queue]
Select the item to add the selected track or all tracks in the selected item to the end of the play queue.
 - [Empty Play queue and add]
Select the item to clear the current play queue and newly add the selected track or all tracks in the selected item to the play queue.
- When [Add to playlist] is selected, a playlist transferred from a computer cannot be selected as the addition destination. In this case, create a new playlist with the same content as the playlist transferred from the computer in advance, and then select that playlist as the addition destination.
On the library screen, tap  (Context menu) to the right side of the playlist transferred from the computer.
Tap the menu items in the following order.
[Add to another playlist] – [Create new playlist].

The contents of the Help Guide may be subject to change without notice due to updates to the product's specifications.

Related Topic

- [How to use the various screens of "Music player"](#)
- [Playing music](#)
- [Playback methods](#)
- [Managing playlists in "Music player"](#)
- [Importing playlists from a Windows computer, playing, or deleting playlists in "Music player"](#)

Favorites screen in “Music player”

You can play tracks/albums/playlists that you have added to Favorites. You can also change the order of items in the content list.

To display the favorites screen

Swipe the playback screen in “Music player” to the left.

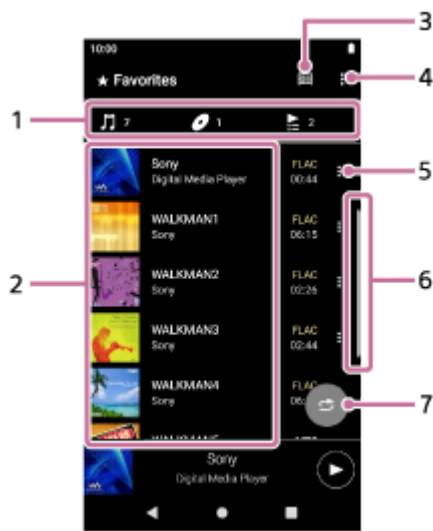

1. Category tabs

Content lists are divided by category (track/album/playlist). Tap a category tab to display a list of content in the desired category.

2. Content list

You can view the items in the selected category.

3. Library top button

4. Options button

5. Context menu button

6. Scroll indicator

7. Shuffle playback button

Tap to start shuffle playback with the displayed track list as the playback range.

Option menu

Tap  (Options) to display the option menu.

Displayed items may differ depending on the screen or settings.

Settings

Select the item to display the Settings menu for “Music player”.

Edit Favorites order

Select the item to change the order of the items in the selected category. Drag and drop the reordering icons on the left sides of the items until they are in the desired order.

Add to playlist

Select the item to add all tracks in Favorites to a playlist.

Play next

Select the item to add all tracks in Favorites to the position after the current track in the play queue.

Add to the end of Play queue

Select the item to add all tracks in Favorites to the end of the play queue.

Empty Play queue and add

Select the item to clear the current play queue and newly add all tracks in Favorites to the play queue.

Remove all

Select the item to remove all items in the selected category from Favorites.

Context menu

Tap  (Context menu) to display the context menu.  (Context menu) will appear to the right side of each item. Displayed items may differ depending on the screen or settings.

Add to playlist

Select the item to add the selected track or all tracks in the selected item to a playlist.

Add to another playlist

Select the item to add all tracks in the selected playlist to another playlist.

Play next

Select the item to add the selected track or all tracks in the selected item to the position after the current track in the play queue.

Add to the end of Play queue

Select the item to add the selected track or all tracks in the selected item to the end of the play queue.

Empty Play queue and add

Select the item to clear the current play queue and newly add the selected track or all tracks in the selected item to the play queue.

Remove from this list

Select the item to remove the item from Favorites.

Detailed song information

Select the item to display the details of the track.

Hint

- You can also display the context menu by holding down an item in the list.
- When [Add to playlist] or [Add to another playlist] is selected, a playlist transferred from a computer cannot be selected as the addition destination. In this case, create a new playlist with the same content as the playlist transferred from the computer in advance, and then select that playlist as the addition destination.
On the library screen, tap  (Context menu) to the right side of the playlist transferred from the computer.
Tap the menu items in the following order.
[Add to another playlist] – [Create new playlist].

Note

- When you remove the microSD card, the following information will disappear.
 - Favorite information for tracks on the microSD card.

Information may remain in the database for "Music player". In this case, when you reinsert the microSD card, the information will reappear.

Related Topic

- [How to use the various screens of "Music player"](#)
- [Playing music](#)
- [Playback methods](#)
- [Managing playlists in "Music player"](#)
- [Importing playlists from a Windows computer, playing, or deleting playlists in "Music player"](#)
- [Managing Favorites in "Music player"](#)

Digital Media Player
NW-WM1AM2/NW-WM1ZM2

Sound adjustment screens for “Music player”

You can use various sound adjustments. You can quickly access the sound adjustment screens from the playback screen in “Music player”. In this case, you do not need to launch the [Sound adjustment] app. You can save up to 10 customized sound adjustments as [Saved sound settings].

To display the sound adjustment screens

Swipe the playback screen in “Music player” upwards.

To navigate the sound adjustment screens

Swipe the screen to the left or right to select a sound adjustment.

You cannot select sound adjustments if you have turned on the following settings. Turn off the settings to enable the other sound adjustments.

- Direct Source
- DSD Remastering

Sound adjustments available

- Equalizer
- DSEE Ultimate™
- DC Phase Linearizer
- Dynamic Normalizer
- Vinyl Processor
- DSD Remastering

To display saved sound settings

On one of the sound adjustment screens, tap  (Saved sound settings).

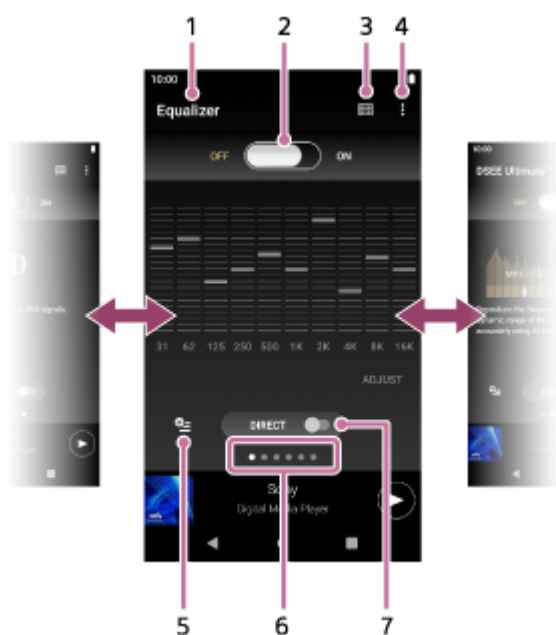

1. Name of the sound adjustment

2. ON/OFF switch

Tap to turn each sound adjustment on or off while keeping the state of the setting.

3. Library top button

4. Options button

5. Saved sound settings button

You can save the current state of the sound adjustments as [Saved sound settings], or load [Saved sound settings] that you have saved.

6. Page indicator

The number of dots represents the number of available pages. Swipe the screen to the left or right to switch to a different page.

7. [DIRECT] switch

You can turn the [Direct Source] function on or off.

Option menu

Tap  (Options) to display the option menu.

Displayed items may differ depending on the screen or settings.

Settings

Select the item to display the Settings menu for "Music player".

Operation guide

Select the item to view the operating guide.

Hint

- You can swipe any of the sound adjustment screens downwards to return to the playback screen.

The contents of the Help Guide may be subject to change without notice due to updates to the product's specifications.

Related Topic









- [How to use the various screens of "Music player"](#)
- [Adjusting the sound](#)

Digital Media Player
NW-WM1AM2/NW-WM1ZM2

List of icons displayed in the status bar

In the status bar, the various statuses of the player appear as icons.



-  Updating the database of "Music player".
-  microSD card mounted
-  HOLD indicator
-  Bluetooth function
-  Wi-Fi network connected
-  Airplane mode
-  Battery status
-  Battery Care function

The contents of the Help Guide may be subject to change without notice due to updates to the product's specifications.

Related Topic

- [WALKMAN Home] screen
- Android Home screen

5-031-748-11(3) Copyright 2022 Sony Corporation

Digital Media Player
NW-WM1AM2/NW-WM1ZM2

Viewing a guide to enjoy high quality sound

You can view information on enjoying content in high sound quality.

- 1 On the [WALKMAN Home] screen, tap  [Guide to quality sound].

The contents of the Help Guide may be subject to change without notice due to updates to the product's specifications.

Digital Media Player
NW-WM1AM2/NW-WM1ZM2

Setting the screen lock

If you activate the screen lock function, the screen will lock automatically when the screen turns off. This can help keep the player secure in case of loss. You can choose from several methods for unlocking the screen.

1 Swipe the [WALKMAN Home] screen upwards.

2 Tap the menu items in the following order.
 [Settings] – [Security] – [Screen lock].

3 Tap the desired method to unlock the screen.

A setting screen may appear depending on the method. Follow the onscreen instructions to complete the setting.

Note

- Be careful not to forget your unlocking code. The information solely belongs to the customer, not to Sony. If you forget how to unlock the screen, contact the nearest Sony dealer or Sony Service Center. The player will be formatted at a fee to erase the screen lock information. Sony assumes no responsibility for any loss or damage of stored data.

The contents of the Help Guide may be subject to change without notice due to updates to the product's specifications.

Digital Media Player
NW-WM1AM2/NW-WM1ZM2

Adjusting the volume

Adjust the volume for “Music player”.

1. Press or hold down the +/- (volume) buttons ([1]).

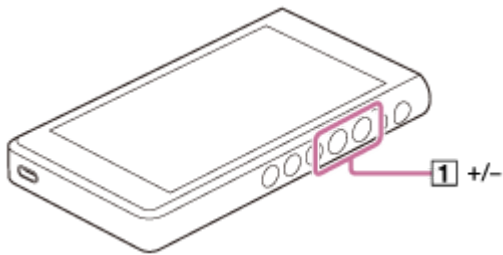

To adjust the volume with the volume dialog

1. Turn on the screen of the player.
2. Press the +/- (volume) buttons ([1]) to display the volume panel.

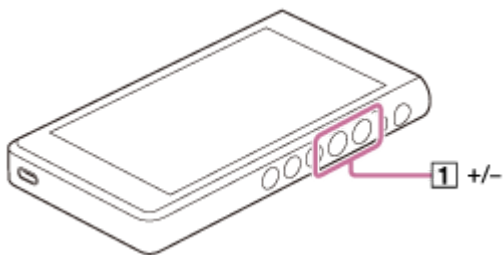

3. Tap the volume scale or the digits on the volume panel to display the volume dialog.

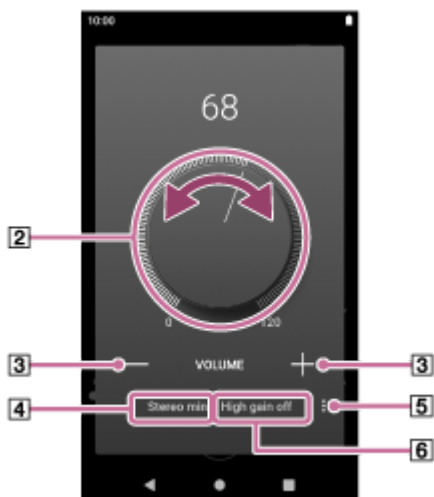

- [2] Volume knob
- [3] +/- (volume)
- [4] Current sound output (Stereo mini or Balanced standard) (*1)
- [5] Options button (High gain output setting) (*1)
- [6] Current setting for [High gain output] of the current sound output (on or off) (*1)

*1 The menu items may not be available in some countries or regions.

4. Turn the volume knob ([2]) to adjust the volume.

The volume for the current sound output ([4]) will be adjusted.

You can also tap or hold down +/- (volume) ([3]) to adjust the volume.

Hint

- You can also display the volume dialog from the Quick Settings panel. On the [WALKMAN Home] screen, swipe down on the status bar twice. Then, tap the volume icon in the Quick Settings panel.
- The volume may be low when you use certain headphones. In this case, switch the output setting to High Gain. Tap [Options] ([5]) to display the High gain output panel. Then, tap the switch next to the type of headphone jack that you are using. (The menu item may not be available in some countries or regions.)
- When you switch between the headphone jack (Balanced Standard) and the headphone jack (Stereo Mini), the volume may become unexpectedly loud. To avoid loud volumes, the player may lower the volume automatically.

Note

- The volume level may be too high or too low when you listen to music using an app other than “Music player”. In this case, adjust the volume according to the following procedure.
Tap [Setting] ([5]) on the volume panel, and adjust the volume level for [Media volume].
Then, adjust the volume with the +/- (volume) buttons ([1]) or the volume dialog.
- The volume level of “Music player” may be too high or too low if you have adjusted the volume while you used another app. In this case, adjust the volume with the +/- (volume) buttons ([1]) or the volume dialog.
- You cannot adjust the volume with the volume dialog in the following cases. Adjust the volume using the connected device.
 - When sound is output through a Bluetooth device that is connected to the player.
 - When sound is output through a USB device that is connected to the player.

Limiting the volume

The AVLS (Automatic Volume Limiter System) function reduces the risk of damage to ears from loud volumes. Using AVLS limits the maximum volume.

AVLS has the following features.

- AVLS limits the volume to a certain level.
- AVLS prevents disturbances to others caused by loud volumes.
- AVLS reduces risks that occur when you cannot hear ambient sound.
- AVLS allows you to listen at a more comfortable volume.

1. Swipe the [WALKMAN Home] screen upwards.

2. Tap the menu items in the following order.

 [Settings] – [Sound].

3. Tap the [AVLS (volume limit)] switch.

Note

- AVLS (volume limit) is not effective in the following cases.
 - When sound is output through a Bluetooth device that is connected to the player.
 - When sound is output through a USB device that is connected to the player.

Related Topic

- [Volume operation in compliance with Directives](#)

5-031-748-11(3) Copyright 2022 Sony Corporation

Digital Media Player
NW-WM1AM2/NW-WM1ZM2

Volume operation in compliance with Directives

The alarm (beep) and warning [Check the volume level.] are intended to protect your ears. They occur when you initially turn the volume up to a harmful level. You can cancel the alarm and warning by tapping [OK] on the alert dialog.

Note

- You can turn up the volume after you cancel the alarm and warning.
- After the initial warning, the alarm and warning will repeat every 20 cumulative hours that the volume is set to a level that is harmful to your ears. When this happens, the volume will turn down automatically.
- If you turn off the player after you have selected a high volume that may damage your eardrums, the volume level will automatically be lower when you turn on the player the next time.
- The alarm will not sound when there is an active Bluetooth connection.

The contents of the Help Guide may be subject to change without notice due to updates to the product's specifications.

Related Topic

- [Adjusting the volume](#)

Digital Media Player
NW-WM1AM2/NW-WM1ZM2

Preparing music content

Before you enjoy music content with the player, you need to prepare the music content. This topic includes instructions for the following operations.

- Purchasing music content from online music services by using the player.
- Importing music content from an audio CD to Music Center for PC.
- Importing music content stored on a Windows® computer to Music Center for PC.
- Importing music content stored on an external media device to a Windows computer.
- Purchasing music content from online music services.

Music Center for PC is a recommended application for Windows computers. Before you transfer music content from a Windows computer to the player, install Music Center for PC on the Windows computer. Ensure that the software version of Music Center for PC is 2.4 or later. In earlier versions, Music Center for PC will not recognize the player.

To transfer music content stored on a Mac computer to the player, use software designed to transfer files on a Mac computer to an Android device.

Purchasing music content from online music services by using the player

If you connect the player to a Wi-Fi network, you can purchase music content from online music services. For details, see [Purchasing music content from online music services by using the player].

Importing music content from an audio CD to Music Center for PC

1. Use a computer on which Music Center for PC has been installed.
2. Launch Music Center for PC.
3. Click [CD] under [Import] in the sidebar.
4. Insert an audio CD into the media drive of the computer.
The music content on the audio CD will appear on the Music Center for PC screen.
You can change the format setting for importing CDs, if necessary. Click next to , and then select a file format from [CD import settings].
 - For higher sound quality: FLAC
 - For normal sound quality: AAC (.mp4), MP3 (.mp3)
5. Add check marks to the music content that you want to import.
6. Click [Import] to start importing music content.
To cancel importing, click [Stop].

For details on the procedure, see [How to use] on the Music Center for PC support website. (<https://www.sony.net/smc4pc/>)

Hint

- You can also use iTunes instead of Music Center for PC to import audio CDs.

Importing music content stored on a computer to Music Center for PC

1. Use a computer on which Music Center for PC has been installed.
2. Launch Music Center for PC.
3. Click  (menu) in the top left of the Music Center for PC screen. Then, select the import method from the [File] menu.
4. Specify folders or files for the music content that you want to import.
5. Start importing music content.

For details on the procedure, see [How to use] on the Music Center for PC support website. (<https://www.sony.net/smc4pc/>)

Importing music content stored on an external media device to a computer

Use an external media device that contains music content.

The following instructions are for Windows Explorer. If you are using a Mac computer, use Finder.

1. Connect the external media device to a computer.
2. Open the external media device in Windows Explorer.
3. Open the [Music] folder of the computer in Windows Explorer.
4. Drag-and-drop the folders or files from the external media device to the [Music] folder on the computer.

Purchasing music content from online music services

You can purchase music content from online music services.

Check the service guide for the provider you use. Each service provider has different downloading procedures, compatible file formats, and payment methods. Note that the provider may choose to suspend or terminate the service without notice.

Note

- Imported music content is limited to private use only. Use of music content for other purposes requires the permission of the copyright holders.

The contents of the Help Guide may be subject to change without notice due to updates to the product's specifications.

Related Topic

- [Connecting the player to a Wi-Fi network](#)
- [Purchasing music content from online music services by using the player](#)
- [Installing Music Center for PC \(Windows\)](#)
- [Transferring content using Windows Explorer](#)
- [Transferring content using Mac computer](#)
- [Playing music](#)

Digital Media Player
NW-WM1AM2/NW-WM1ZM2

Purchasing High-Resolution Audio content by using a computer

High-Resolution Audio refers to audio content in a format with higher sound quality than the CD standard. To purchase High-Resolution Audio content, connect your computer to the internet, and access an online music service that provides High-Resolution Audio content.

Services vary by country or region. Check the service guide for the provider you use. Each service provider has different downloading procedures, compatible file formats, and payment methods. Note that the provider may choose to suspend or terminate the service without notice.

To transfer High-Resolution Audio content from the computer to the player

- On a Windows computer: You can use Music Center for PC (version 2.4 or later) or Windows Explorer.
- On a Mac computer: To transfer music content stored on a Mac computer to the player, use software designed to transfer files on a Mac computer to an Android device.

Hint

- High-Resolution Audio content is indicated with an icon () both on "Music player" and in Music Center for PC.

The contents of the Help Guide may be subject to change without notice due to updates to the product's specifications.

Related Topic

- [Purchasing High-Resolution Audio content by using the player](#)
- [Installing Music Center for PC \(Windows\)](#)
- [Transferring content from a Windows computer using Music Center for PC](#)
- [Transferring content using Windows Explorer](#)
- [Transferring content using Mac computer](#)

Digital Media Player
NW-WM1AM2/NW-WM1ZM2

Installing Music Center for PC (Windows)

Music Center for PC is a recommended application for Windows computers. Before you transfer music content from a Windows computer to the player, install Music Center for PC on the Windows computer.

Ensure that the software version of Music Center for PC is 2.4 or later. In earlier versions, Music Center for PC will not recognize the player.

You can use Music Center for PC to perform the following operations.

- Importing music content from CDs to a computer.
- Organizing and managing the content.
For example, you can create playlists.
- Transferring content on a computer to the player.

Confirm the system requirements before you install Music Center for PC.

1 Access the Music Center for PC download website.

<https://www.sony.net/smc4pc/>

2 Install Music Center for PC.

For details on installation, see [Download] – [Installation procedure] on the Music Center for PC support website.
(<https://www.sony.net/smc4pc/>)

The contents of the Help Guide may be subject to change without notice due to updates to the product's specifications.

Related Topic

- [Preparing music content](#)
- [Transferring content from a Windows computer using Music Center for PC](#)
- [System requirements](#)

Digital Media Player
NW-WM1AM2/NW-WM1ZM2

Transferring content from a Windows computer using Music Center for PC

You can transfer music content that is stored on a Windows computer to the player via Music Center for PC.

Note

- Ensure that the software version of Music Center for PC is 2.4 or later. In earlier versions, Music Center for PC will not recognize the player.
- If you connect the player to a battery-powered computer, the battery of the computer will deplete. When you connect the player to a computer for a long period of time, connect the computer to an AC power supply.

1 Use a computer on which Music Center for PC has been installed.

2 Launch Music Center for PC.

3 Connect the player to the computer via USB.



4 Confirm the [Use USB for] menu on the player. Select [File Transfer], and tap [OK].

If the [Use USB for] menu does not appear, you can access the menu from the Settings app.

Swipe the [WALKMAN Home] screen upwards.

Tap the menu items in the following order.

⚙️ [Settings] – [Connected devices] – [USB].

The transfer screen for the player will appear on the right side of Music Center for PC.

A list of the music content in Music Center for PC will appear on the left side of Music Center for PC.

5 Select a destination from the transfer screen.

To transfer music content to the microSD card in the player:

Select the microSD card from the device selection menu on the transfer screen.

6 Select albums or tracks from the left side.

7 Click ➡️ to transfer.

For details on the procedure, see [How to use] on the Music Center for PC support website.

(<https://www.sony.net/smc4pc/>)

Hint

- The ATRAC format is not supported on the player. ATRAC files will be converted to the AAC format to transfer to the player. If you want to convert ATRAC files to another file format, use [Batch convert ATRAC] in Music Center for PC.
- [Batch convert ATRAC] allows you to simultaneously convert all ATRAC files in the library of Music Center for PC to another file format.

Note

- Do not disconnect the USB Type-C cable during data transfer (USB Type-C cable: supplied). Otherwise, the data may be damaged.
- Transferred music content is limited to private use only. Use of music content for other purposes requires the permission of the copyright holders.
- The use of a USB hub is only guaranteed when you use a self-powered USB hub that carries an authorized logo.
- While the player is connected to a computer, observe the following cautions. Otherwise, the player may not function properly.
 - Do not turn on the computer.
 - Do not restart the computer.
 - Do not wake the computer from sleep mode.
 - Do not shut down the computer.
- While you are transferring or importing music content on Music Center for PC, make sure that the computer does not enter the sleep mode or standby mode.
The data may be lost or Music Center for PC may not reboot normally.

Instructional video

There is an instructional video for the following operations.

- Transferring music content.

Visit the following link.

https://rd1.sony.net/help/dmp/mov0007/h_zz/

The contents of the Help Guide may be subject to change without notice due to updates to the product's specifications.

Related Topic

- [Installing Music Center for PC \(Windows\)](#)
- [Preparing music content](#)
- [Purchasing High-Resolution Audio content by using a computer](#)
- [Transferring content using Windows Explorer](#)
- [Playing music](#)
- [Supported formats](#)

Digital Media Player
NW-WM1AM2/NW-WM1ZM2

Transferring content using Windows Explorer

You can transfer music content directly by dragging and dropping it from Windows Explorer. “Music player” can only play the audio for video content.

Note

- If you connect the player to a battery-powered computer, the battery of the computer will deplete. When you connect the player to a computer for a long period of time, connect the computer to an AC power supply.

1 Connect the player to the computer via USB.



2 Confirm the [Use USB for] menu on the player. Select [File Transfer], and tap [OK].

If the [Use USB for] menu does not appear, you can access the menu from the Settings app.

Swipe the [WALKMAN Home] screen upwards.

Tap the menu items in the following order.

 [Settings] – [Connected devices] – [USB].

3 Open the [WALKMAN] folder as follows.

- Windows 10:
Open [File Explorer] from the [Start] menu. Select [WALKMAN] from the left pane.
- Windows 8.1:
Open [File Explorer] from [Desktop]. Select [WALKMAN] from the list under [This PC].

4 Open the [Music] folder in [Internal shared storage].

You can also transfer music content to a microSD card.

Select the folder with the name of the microSD card instead of [Internal shared storage].

5 Drag-and-drop the files or folders on the computer to the [Music] folder.

Drag-and-drop video content to the [Music] folder as well.

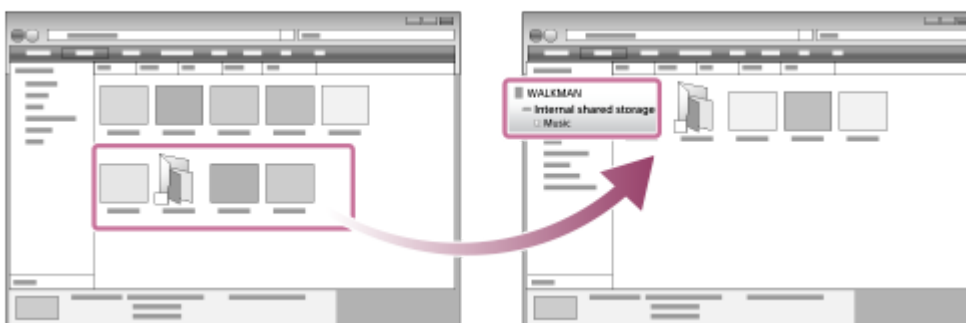

Confirm that the transfer is complete. Then, disconnect the player from the computer.

Hint

- Refer to [Supported formats] for details on compatible file formats.
- You can add cover art images for albums manually so that the image will appear on “Music player”. First, rename the image file with the same name as the folder for the album. (Do not change the extension for the image file at this time.) Then, add the image file to the folder for the album.
“Music player” displays the following files for cover art images.
 - Baseline JPEG
 - Progressive JPEG
 - Non-interlaced PNG
 - Interlaced PNG

Note

- Observe the following precautions. Otherwise, “Music player” may not be able to play the files.
 - Do not change the names of the default folders (such as [Music]).
 - Do not transfer the files to folders other than [Music].
 - Do not disconnect the USB Type-C cable during data transfer (USB Type-C cable: supplied).
 - Do not format the memory of the player on the computer.
- The player may not display information for some music content correctly depending on the language setting on the player.
- Transferred music content is limited to private use only. Use of music content for other purposes requires the permission of the copyright holders.
- The use of a USB hub is only guaranteed when you use a self-powered USB hub that carries an authorized logo.
- While the player is connected to a computer, observe the following cautions. Otherwise, the player may not function properly.
 - Do not turn on the computer.
 - Do not restart the computer.
 - Do not wake the computer from sleep mode.
 - Do not shut down the computer.

Instructional video

There is an instructional video for the following operations.

- Transferring music content.

Visit the following link.

https://rd1.sony.net/help/dmp/mov0007/h_zz/

The contents of the Help Guide may be subject to change without notice due to updates to the product's specifications.

Related Topic

- [Preparing music content](#)
- [Purchasing High-Resolution Audio content by using a computer](#)
- [Transferring content from a Windows computer using Music Center for PC](#)
- [Playing music](#)

Importing content from “Music player” to Music Center for PC

Note

- Ensure that the software version of Music Center for PC is 2.4 or later. In earlier versions, Music Center for PC will not recognize the player.
- If you connect the player to a battery-powered computer, the battery of the computer will deplete. When you connect the player to a computer for a long period of time, connect the computer to an AC power supply.

1 Use a computer on which Music Center for PC has been installed.

2 Launch Music Center for PC.

3 Connect the player to the computer via USB.



4 Confirm the [Use USB for] menu on the player. Select [File Transfer], and tap [OK].

If the [Use USB for] menu does not appear, you can access the menu from the Settings app.

Swipe the [WALKMAN Home] screen upwards.

Tap the menu items in the following order.

 [Settings] – [Connected devices] – [USB].

The transfer screen for the player will appear on the right side of Music Center for PC.

A list of the music content in Music Center for PC will appear on the left side of Music Center for PC.

To import music content from the microSD card in the player:

Select the microSD card from the device selection menu on the transfer screen.

5 Click [Manage songs in device] to display the list of music content on “Music player”.

6 Select the music content that you want to import to Music Center for PC.

7 Right-click the music content to select [Import to PC].

For details on the procedure, see [How to use] on the Music Center for PC support website.

(<https://www.sony.net/smc4pc/>)

Note

- Do not disconnect the USB Type-C cable during data transfer (USB Type-C cable: supplied). Otherwise, the data may be damaged.

- Imported music content is limited to private use only. Use of music content for other purposes requires the permission of the copyright holders.
- The use of a USB hub is only guaranteed when you use a self-powered USB hub that carries an authorized logo.
- While the player is connected to a computer, observe the following cautions. Otherwise, the player may not function properly.
 - Do not turn on the computer.
 - Do not restart the computer.
 - Do not wake the computer from sleep mode.
 - Do not shut down the computer.

The contents of the Help Guide may be subject to change without notice due to updates to the product's specifications.

Related Topic

- [Installing Music Center for PC \(Windows\)](#)
- [Playing music](#)
- [Supported formats](#)

5-031-748-11(3) Copyright 2022 Sony Corporation

Digital Media Player
NW-WM1AM2/NW-WM1ZM2

Transferring content using Mac computer

To transfer music content stored on a Mac computer to the player, use software designed to transfer files on a Mac computer to an Android device.

The contents of the Help Guide may be subject to change without notice due to updates to the product's specifications.

Related Topic

- [Preparing music content](#)
- [Supported formats](#)

Digital Media Player
NW-WM1AM2/NW-WM1ZM2

Adding lyric information using a computer

You can input lyrics to a text file (an LRC file). Transfer both the text file (LRC file) and the music file to the player.

Creating lyrics in a text file (LRC file)

1. Open the [Notepad] in Windows Accessories.
2. Enter the lyrics into [Notepad].
3. Play the track and enter the time to display each line of text.

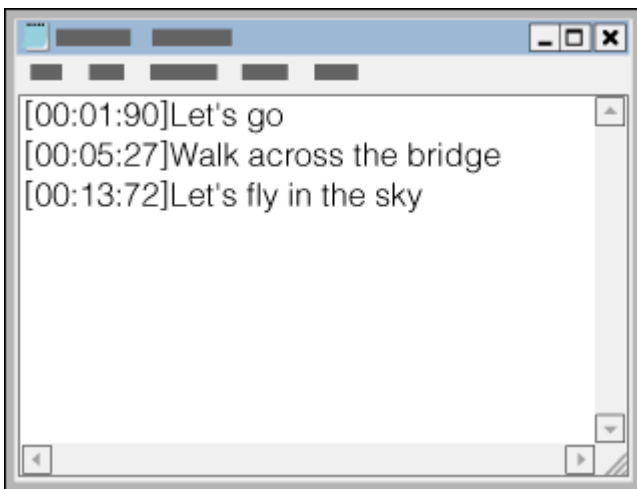

- You can enter the time information to the left of each line of text in the following format.
Minutes:seconds:hundredths of a second (*1)
- Time information must be entered in chronological order.
- You can separate seconds and hundredths of a second using a period instead of a colon.

*1 You can omit hundredths of a second.

4. Save the file.
 - Select [UTF-8] as the character encoding.
 - Set the same file name as the music file.
 - Set [.lrc] as the extension.
 - The maximum file size is 512 KB.
 - If a text line cannot fit on the screen, it will be wrapped.
 - The number of lines of text that can be displayed simultaneously depends on the model.
 - CR, CRLF, and LF line breaks are all recognized.
 - Blank text lines will be skipped.
5. Connect the player to the computer via USB.
6. Open the [WALKMAN] folder according to one of the following procedures.
 - Windows 10:
Open [File Explorer] from the [Start] menu. Select [WALKMAN] from the left pane.
 - Windows 8.1:
Open [File Explorer] from [Desktop]. Select [WALKMAN] from the list under [This PC].

7. Create a new folder in the [Music] folder under [Internal shared storage]. Then, drag-and-drop both the music file and the LRC file into the new folder to transfer them.

You can also transfer music files to a microSD card.

Select the folder with the name of the microSD card instead of [Internal shared storage].

Hint

- The following numbers of characters are recommended when you display lyrics on “Music player”.
 - Single-byte characters (for example, alphanumeric characters): 40 characters per line.
 - 2-byte characters (for example, Chinese characters): 20 characters per line.
- Save the LRC files in the same folder as the music files. The LRC files will be transferred to the player when the music files are transferred.
- On a Mac computer, you can create lyrics using “TextEdit” and other text editors. Follow the same procedure as that described above to enter the lyrics or time information in the “Plain text” setting.

Copyright notice

When you create LRC files using copyrighted materials authored by others, the LRC files are limited to private use only. Use of LRC files for other purposes requires the permission of the copyright holders.

The contents of the Help Guide may be subject to change without notice due to updates to the product's specifications.

Related Topic

- [Obtaining lyric information](#)
- [Displaying lyrics](#)

Digital Media Player
NW-WM1AM2/NW-WM1ZM2

Notes on transferring content from a computer

Drag-and-drop music files into the correct folder as shown in the following illustration.

The player can play back music files stored in the first through eighth level of each folder.

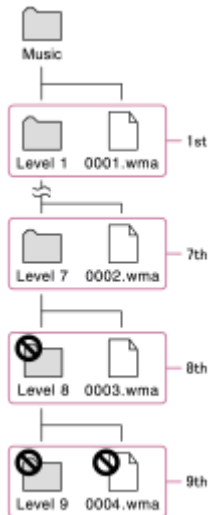

Hint

- You can transfer video content to the [Music] folder. “Music player” can only play the audio for video content.

Note

- “Music player” cannot recognize folders stored in the eighth level of a folder.
- Do not rename the following default folders. Otherwise, “Music player” will not recognize the folders.
 - Music

The contents of the Help Guide may be subject to change without notice due to updates to the product's specifications.

Digital Media Player
NW-WM1AM2/NW-WM1ZM2

Connecting the player to a Wi-Fi network

Connect the player to a Wi-Fi network to enjoy the following.

- Music streaming services
- Music downloads

1 Swipe the [WALKMAN Home] screen upwards.

2 Tap the menu items in the following order.
 [Settings] – [Network & internet] – [Wi-Fi].

3 Tap the desired network in the list.

4 Enter a password and tap [CONNECT].

[Connected] will appear under the network name when the player establishes a connection.

To turn the Wi-Fi function on or off

Swipe the [WALKMAN Home] screen upwards.

Tap the menu items in the following order.

 [Settings] – [Network & internet].

Tap the Wi-Fi switch to turn the function on or off.

Hint

- You can also turn the Wi-Fi function on or off from the Quick Settings panel. On the [WALKMAN Home] screen, swipe down on the status bar twice. Then, tap the Wi-Fi icon in the Quick Settings panel.
- To determine the network name, check the following items.
 - Wi-Fi router
 - Instruction manual for the Wi-Fi router
 - Service agreement for the Wi-Fi network

The following terms may also refer to the network name.

- Network SSID
- SSID
- ESSID
- Access Point Name (APN)

- To determine the network password, check the following items.
 - Wi-Fi router
 - Instruction manual for the Wi-Fi router
 - Service agreement for the Wi-Fi network

The following terms may also refer to the network password.

- Encryption key
- KEY
- WEP key
- Security key
- Pass phrase

Note

- The network password (Encryption key, etc.) is case sensitive. Make sure that you are entering correct uppercase and lowercase characters.
- Examples of easily mistaken characters:
 - “l (uppercase l)” and “l (lowercase L)”
 - “0 (numeral 0)” and “O (uppercase O)”
 - “d (lowercase D)” and “b (lowercase B)”
 - “9 (numeral 9)” and “q (lowercase Q)”

Instructional video

There is an instructional video for the following operations.

- Setting up a Wi-Fi connection.

Visit the following link.

https://rd1.sony.net/help/dmp/mov0006/h_zz/

The contents of the Help Guide may be subject to change without notice due to updates to the product's specifications.

Related Topic

- [Notes on security when connecting to the internet](#)
- [Purchasing music content from online music services by using the player](#)

Digital Media Player
NW-WM1AM2/NW-WM1ZM2

Setting up a Google Account

Set up a Google Account to use services provided by Google. You can register multiple accounts on the player. You can also register an existing Google Account, such as the account that you use on your computer.

You can create a new Google Account for free. Having a Google Account allows you to enjoy services as follows.

- Installing apps from the Google Play store.
- Using apps such as e-mail and calendar.

1 Turn on the Wi-Fi function to connect the player to the internet.

2 Swipe the [WALKMAN Home] screen upwards.

3 Tap  [Settings].

4 Open the account menu, and add an account.

Follow the onscreen instructions to complete the setting.

Note

- Ensure that the player is connected to the internet through a Wi-Fi network when you perform the following.
 - Setting up a Google Account.
 - Signing in to a Google Account.

The contents of the Help Guide may be subject to change without notice due to updates to the product's specifications.

Related Topic



- [Connecting the player to a Wi-Fi network](#)

Digital Media Player
NW-WM1AM2/NW-WM1ZM2

Purchasing music content from online music services by using the player

If you connect the player to a Wi-Fi network, you can purchase music content from online music services. You need to install an online music service app in advance.

Check the service guide for the provider you use. Each service provider has different downloading procedures, compatible file formats, and payment methods. Note that the provider may choose to suspend or terminate the service without notice.

- 1 Turn on the Wi-Fi function to connect the player to the internet.
- 2 Swipe the [WALKMAN Home] screen upwards, and then tap  [Play Store].
- 3 Search for the desired app.
- 4 Follow the onscreen instructions to install the app.
- 5 Launch the app.
If necessary, follow the instructions from the provider to register an account, select a payment method, and so on.
- 6 Purchase music content.
- 7 On the library screen in “Music player”, tap  (Update database).

Note

- The destination for music downloads differs depending on the online music service. If content is not in one of the following folders, the content will not appear in the library of “Music player”.
 - [Music] folder in the memory of the player
 - [Download] folder in the memory of the player
 - [Music] folder on the microSD card

In this case, use the [Files] app to move the content to one of the folders listed above.

The contents of the Help Guide may be subject to change without notice due to updates to the product's specifications.

Related Topic

- [Connecting the player to a Wi-Fi network](#)
- [Library screen in “Music player”](#)

Digital Media Player
NW-WM1AM2/NW-WM1ZM2

Purchasing High-Resolution Audio content by using the player

High-Resolution Audio refers to audio content in a format with higher sound quality than the CD standard. To purchase High-Resolution Audio content, connect the player to the internet, and access an online music service that provides High-Resolution Audio content.

Services vary by country or region. Check the service guide for the provider you use. Each service provider has different downloading procedures, compatible file formats, and payment methods.

Note that the provider may choose to suspend or terminate the service without notice.

Hint

- High-Resolution Audio content is indicated with an icon () on “Music player”.

The contents of the Help Guide may be subject to change without notice due to updates to the product's specifications.

Related Topic

- [Connecting the player to a Wi-Fi network](#)



Digital Media Player
NW-WM1AM2/NW-WM1ZM2

Installing apps to enjoy online music services

Access the Google Play store and install music apps on the player. You can enjoy music streaming services on the player.

- 1 Turn on the Wi-Fi function to connect the player to the internet.
- 2 Swipe the [WALKMAN Home] screen upwards, and then tap  [Play Store].
- 3 Search for the desired app.
- 4 Follow the onscreen instructions to install the app.

Hint

- You need to have a Google Account to use the Google Play Store.
- For details on how to use apps, refer to the information for the app.
- The following apps are installed on the player at the time of purchase.
 -  [YouTube]
 -  [YouTube Music]

The contents of the Help Guide may be subject to change without notice due to updates to the product's specifications.

Related Topic

- [Connecting the player to a Wi-Fi network](#)
- [Setting up a Google Account](#)

Digital Media Player
NW-WM1AM2/NW-WM1ZM2

Enjoying the 360 Reality Audio service

You can perform personalization for 360 Reality Audio using the player and a smartphone with a camera.

- 1 Turn on the Wi-Fi function to connect the player to the internet.
- 2 On the [WALKMAN Home] screen, tap  [Sony | Headphones Connect].
- 3 Follow the onscreen instructions to install the Sony | Headphones Connect app.
- 4 Launch the Sony | Headphones Connect app.
- 5 Register your headphones.
- 6 Follow the onscreen instructions to set up the data for personalization.
- 7 Select an online music service in Sony | Headphones Connect to complete personalization.

Hint

- You need to have a Google Account to use the Google Play Store.
- For details on how to use apps, refer to the information for the app.

Note

- You need to update both the Sony | Headphones Connect app and the system software of the player to the latest version.
- Requires a subscription to a music-streaming service – subscription fees apply. Some services may not be available in certain countries/regions.
- Personalization for 360 Reality Audio takes effect only when using compatible headphones.
- For details on 360 Reality Audio, refer to the following website.
<https://www.sony.net/360RA/>

The contents of the Help Guide may be subject to change without notice due to updates to the product's specifications.

Related Topic

- [Connecting the player to a Wi-Fi network](#)
- [Updating the system software](#)

Digital Media Player
NW-WM1AM2/NW-WM1ZM2

Notes on Wi-Fi connections

- Local regulations may restrict the use of Wi-Fi devices in some countries or regions.
- Wi-Fi devices work on the 2.4 GHz and 5 GHz bands. Various devices use these bands. Wi-Fi devices use technology to minimize radio interference from other devices on the same band. However, radio interference may cause the following effects.
 - Slower data transfer rates
 - Smaller communication range
 - Communication failure
- If you enable both the Wi-Fi function and the Bluetooth function on the player, slower data transfer rates or other problems may occur.
- To perform Wi-Fi communications outdoors, you may need to contract with a Wi-Fi service provider.
- The data transfer rate and communication range may vary depending on the following conditions.
 - Distance between devices
 - Obstructions between devices
 - Device configuration
 - Signal conditions
 - Surrounding environment (wall material, etc.)
 - Software in use
- Communications may cut off depending on signal conditions.
- The data transfer rate is the theoretical maximum. It does not indicate the actual data transfer rate.
- Wi-Fi devices work on the 2.4 GHz and 5 GHz frequency bands. These frequency bands cannot communicate with each other.
- If the data transfer rate is slow, you may be able to increase the rate by changing the wireless channel on the access point.
- The Wi-Fi antenna is built into the player. If you cover the antenna with your hands or other objects, the Wi-Fi connection may deteriorate.

The contents of the Help Guide may be subject to change without notice due to updates to the product's specifications.

Related Topic

- [Parts and controls](#)

Digital Media Player
NW-WM1AM2/NW-WM1ZM2

Notes on security when connecting to the internet

When connecting the player to the internet, be sure to connect via a router (*1) with appropriate security settings. If there is a security issue, the player may be attacked by malware (malicious software), etc. via the internet. Your information and digital assets may be exposed to threats such as extraction and falsification. Not only that, but the player may also unknowingly damage other network services.

*1 A router is a device that relays between an internet line and a local network line. There are the following types.

- Wired router
- ADSL modem with router function
- Optical network unit (ONU) with router function
- Wi-Fi access point with router function
- Wall socket (wall outlet) device with network line (*2)

*2 If you are uncertain whether a wall socket (wall outlet) device with a network line has a router function, please check with the manager of the housing complex or the internet provider.

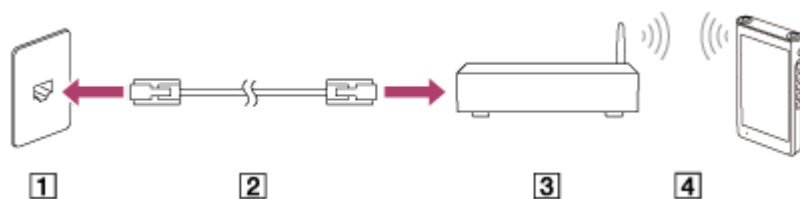

- 1 LAN terminal in the wall
- 2 LAN cable
- 3 Router
- 4 Wireless LAN

The contents of the Help Guide may be subject to change without notice due to updates to the product's specifications.

Digital Media Player
 NW-WM1AM2/NW-WM1ZM2

Playing music

To play tracks, first select a category.

You need to prepare music content in advance. You can purchase music content from online music services. Also, you can transfer music content from a computer to the player.

On a Windows computer

- Use Music Center for PC to transfer content to the player.
- Drag-and-drop content from Windows Explorer.

On a Mac computer

- To transfer music content stored on a Mac computer to the player, use software designed to transfer files on a Mac computer to an Android device.

1 On the [WALKMAN Home] screen, tap  [Music player] to display the library screen.

2 Tap the desired category (**1**).

You can swipe the screen to the left or right to switch pages. The number of dots represents the number of available pages (**2**).

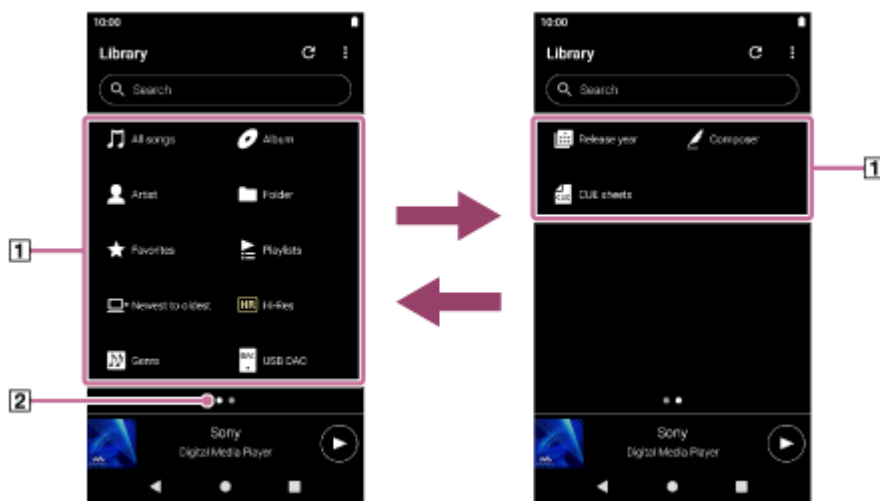

3 Select subcategories until a track list appears, and then select the desired track.

Playback will start.

To play tracks in the desired order

You can check the order of tracks that the player will play on the play queue screen. The play queue can be edited freely by changing the order of tracks, removing tracks, or adding tracks or items.

- **Changing the order of the tracks in the play queue:**

On the play queue screen, tap the menu items in the following order.

 (Options) – [Edit song order].

Drag and drop the reordering icons on the left sides of the tracks until they are in the desired order.

- **Removing a track from the play queue:**

On the play queue screen, tap  (Context menu) to the right side of a track, tap [Remove from this list].

- **Adding a track to the play queue:**

On the library screen or the favorites screen, tap  (Context menu) to the right side of an item, and then tap one of the following items.

- [Play next]

Select the item to add the selected track or all tracks in the selected item to the position after the current track in the play queue.

- [Add to the end of Play queue]

Select the item to add the selected track or all tracks in the selected item to the end of the play queue.

- [Empty Play queue and add]

Select the item to clear the current play queue and newly add the selected track or all tracks in the selected item to the play queue.

Playback operating buttons on the player

- **▶|| (play/pause)**

Press the button to start or pause playback.

- **◀◀ (previous track)**

Press the button to skip to the beginning of the current track or the previous track.

Hold down the button to fast rewind the track while playing.

- **▶▶ (next track)**

Press the button to skip to the beginning of the next track.

Hold down the button to fast forward the track while playing.

Note

- A content stored on the player may not appear in the library of "Music player". In this case, ensure that the file is in the [Music] folder or the [Download] folder in the memory of the player, or in the [Music] folder on the microSD card. Also, tap  (Update database).

The tracks will be registered to the database for "Music player". Then, the tracks will appear in the library.

The contents of the Help Guide may be subject to change without notice due to updates to the product's specifications.

Related Topic

- [How to use the various screens of "Music player"](#)
- [Library screen in "Music player"](#)
- [Playback screen in "Music player"](#)
- [Play queue screen in "Music player"](#)
- [Preparing music content](#)
- [Transferring content from a Windows computer using Music Center for PC](#)
- [Transferring content using Windows Explorer](#)
- [Transferring content using Mac computer](#)
- [Playback methods](#)

Playback methods



This topic includes instructions for the following operations.



- Selecting the playback mode.
- Setting the playback range.
- The relationship between playback mode and playback range.



Selecting the playback mode



1. On the playback screen in “Music player”, tap the area (**1** or **2**) to select a playback mode.

-  (Shuffle)
-  (Repeat 1 song)
-  (Repeat all)

When  (Shuffle) and  (Repeat all) are lit up, “Music player” will play all tracks in the selected playback range randomly.

To return to the normal playback mode, tap the icons so that both  (Shuffle) and  (Repeat) darken.

Hint



- You can also set the playback mode from the option menu. Tap the menu items in the following order.
 (Options) – [Settings].
Then, select the desired playback mode from [Shuffle] or [Repeat].
- When a track list is displayed, you can start shuffle playback with the displayed track list as the playback range by tapping the shuffle playback button.

Setting the playback range



1. Tap the menu items in the following order.
 (Options) – [Settings] – [Playback range].
2. Tap the desired playback range.

The relationship between playback mode and playback range

When you set [Playback range] to [All range]

-  (Shuffle)
All tracks are played in random order.
To shuffle all the tracks in “Music player”, select [All songs] on the library screen.
If you select a track from [Album] on the library screen, “Music player” will shuffle all the tracks in the selected album.
When “Music player” finishes playing all the tracks in the album, playback will proceed to the next album. Then, “Music player” will shuffle all the tracks in the album.
- **Repeat off**
All tracks are played in sequential order.
-  (Repeat all)
All tracks are played repeatedly.
To repeat all the tracks in “Music player”, select [All songs] on the library screen.
-  (Repeat 1 song)
The current track is played repeatedly.

When you set [Playback range] to [Selected range]

-  (Shuffle)
Tracks in the selected range are played in random order. (*1)
- **Repeat off**
Tracks in the selected range are played in sequential order. (*1)
-  (Repeat all)
Tracks in the selected range are played repeatedly. (*1)
-  (Repeat 1 song)
The current track is played repeatedly.

*1 “Selected range” means one album or one artist, for example.

Note

- When you select a track from a playlist or Favorites, “Music player” plays tracks in the selected item only. Tracks in other items will not be played even when [Playback range] is set to [All range].
- When you search by keyword on the library screen and select a track from search results, “Music player” plays the selected track only. Other tracks in the search results will not be played even when [Playback range] is set to [All range].

The contents of the Help Guide may be subject to change without notice due to updates to the product’s specifications.

Related Topic

- [How to use the various screens of “Music player”](#)
- [Playback screen in “Music player”](#)
- [Playing music](#)

Digital Media Player
NW-WM1AM2/NW-WM1ZM2

Obtaining lyric information

To display lyric information on “Music player”, you need to transfer a lyric text file (LRC file) together with the track file to the player.

You can obtain lyric information in the following ways.

- Obtain lyric information via the internet, and then create a text file (LRC file).
- Input lyrics to a text file (LRC file) by yourself.

For details on LRC files, refer to the relevant topic under [Related Topic].

Note

- Lyric information is limited to private use only. Use of lyric content for other purposes requires the permission of the copyright holders.

The contents of the Help Guide may be subject to change without notice due to updates to the product's specifications.

Related Topic

- [Displaying lyrics](#)
- [Adding lyric information using a computer](#)

Digital Media Player
NW-WM1AM2/NW-WM1ZM2

Displaying lyrics

Transfer tracks with lyric information to the player. Then, set “Music player” to display lyrics.

- 1 On the playback screen in “Music player”, tap the menu items in the following order.
 (Options) – [Display lyrics].

The contents of the Help Guide may be subject to change without notice due to updates to the product's specifications.

Related Topic

- [Obtaining lyric information](#)
- [Adding lyric information using a computer](#)

Digital Media Player
NW-WM1AM2/NW-WM1ZM2



Managing playlists in “Music player”

You can collect tracks and save them as a playlist in “Music player”.
This topic includes instructions for the following operations.

- Creating a playlist in “Music player”.
- Listening to a playlist in “Music player”.
- Editing a playlist in “Music player”.
- Deleting a playlist in “Music player”.

Creating a playlist in “Music player”

You can save playlists to the memory of the player.

1. On the library screen in “Music player”, tap [Playlists].
2. Tap the menu items in the following order.
 (Options) – [Create new playlist].
3. Enter the name of the playlist, and then tap [OK].
4. Add tracks to the playlist.
 - Perform one of the following.
 - **While “Music player” is playing or pausing a track:**
On the playback screen, tap the menu items in the following order.
 (Options) – [Add to playlist].
Tap the name of the playlist you have created.
 - **When a list (tracks, albums, play queue, etc.) is displayed:**
Tap  (Context menu) to the right side of an item, tap [Add to playlist], and then tap the name of the playlist you have created.

Hint

- You can change the name of a playlist. On the library screen, tap  (Context menu) to the right side of the playlist, tap [Rename playlist], and then enter the name of the playlist.

Listening to a playlist in “Music player”

1. On the library screen in “Music player”, tap [Playlists] to display the list of playlists.
2. Tap the desired playlist.
3. Tap the desired track.

Hint

- You can listen to playlists that have been added to Favorites from the favorites screen as well.
On the favorites screen, select the playlist tab, and then tap the desired playlist.

Editing a playlist in “Music player”

1. On the library screen in “Music player”, tap [Playlists] to display the list of playlists.

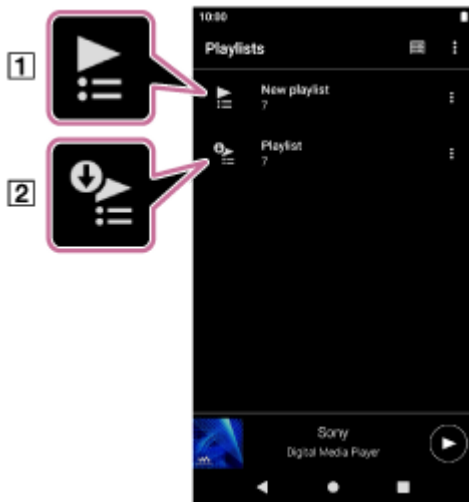

- 1 Playlist created in “Music player”
- 2 Playlist transferred from the computer

2. Tap a playlist created in “Music player” (1) to display the track list.
3. Perform one of the following.

- **Changing the order of tracks in the playlist:**

Tap the menu items in the following order.

☰ (Options) – [Edit song order].

Drag and drop the reordering icons on the left sides of the tracks until they are in the desired order.

- **Removing a track from the playlist:**

Tap ☰ (Context menu) to the right side of the track, and then tap [Remove from this list].

Hint

- You can remove all tracks from a playlist. On the library screen, tap [Playlists] to display the list of playlists. Tap the desired playlist, and then tap the menu items in the following order.
☰ (Options) – [Remove all].
Confirm the message and tap [YES].

To edit a playlist transferred from a computer

You cannot edit a playlist transferred from a computer (2) with “Music player”. As an alternative, you can create a new playlist in “Music player” with the same content as the playlist transferred from the computer. That new playlist can be edited.

For details on operations, see [Importing playlists from a Windows computer, playing, or deleting playlists in “Music player”].

Deleting a playlist in “Music player”

1. On the library screen in “Music player”, tap [Playlists] to display the list of playlists.
2. Tap ☰ (Context menu) to the right side of the playlist, and then tap [Delete].
3. Confirm the message and tap [YES].

Hint

- You can delete all playlists. On the library screen, tap [Playlists] to display the list of playlists. Tap the menu items in the following order.
⋮ (Options) – [Delete all playlists].
Confirm the message and tap [YES].

The contents of the Help Guide may be subject to change without notice due to updates to the product's specifications.

Related Topic

- [Library screen in “Music player”](#)
- [Importing playlists from a Windows computer, playing, or deleting playlists in “Music player”](#)

5-031-748-11(3) Copyright 2022 Sony Corporation

Digital Media Player
NW-WM1AM2/NW-WM1ZM2

Importing playlists from a Windows computer, playing, or deleting playlists in “Music player”

You can import playlists stored on a Windows computer to “Music player”.
This topic includes instructions for the following operations.

- Importing playlists stored on a Windows computer to “Music player”.
- Listening to playlists on “Music player”.
- Deleting a playlist from “Music player”.

Importing playlists stored on a Windows computer to “Music player”

You can transfer playlist files to the following storage destinations.

- Internal memory of the player.
- microSD card inserted into the player.

“Music player” can recognize the m3u file format as a playlist.

The following are instructions for using Music Center for PC (version 2.4 or later). This application is recommended to manage files on the player.

1. Connect the player to the computer via USB.



2. Confirm the [Use USB for] menu on the player. Select [File Transfer] and tap [OK].
If the [Use USB for] menu does not appear, you can access the menu from the Settings app.
Swipe the [WALKMAN Home] screen upwards.
Tap the menu items in the following order.
⚙️ [Settings] – [Connected devices] – [USB].
The transfer screen for the player will appear on the right side of Music Center for PC.
A list of the music content in Music Center for PC will appear on the left side of Music Center for PC.
3. Select a destination from the transfer screen.
To transfer music content to the microSD card in the player:
Select the microSD card from the device selection menu on the transfer screen.
4. Select playlists from the left side.
Then, click ➡️ to transfer.

Note

- You cannot import a single playlist to both the player memory and a microSD card.

Listening to playlists on “Music player”

1. On the library screen in “Music player”, tap [Playlists] to display the list of playlists.
2. Tap the desired playlist.
3. Tap the desired track.

Deleting a playlist from “Music player”

1. On the library screen in “Music player”, tap [Playlists] to display the list of playlists.

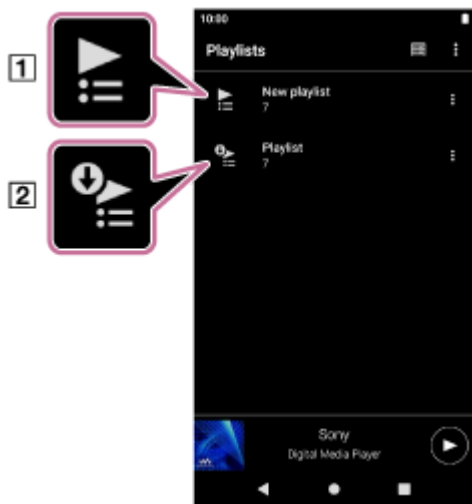

- 1 Playlist created in “Music player”
- 2 Playlist transferred from the computer

2. Tap  (Context menu) to the right side of the playlist transferred from the computer (2).
3. Tap [Delete].
4. Confirm the message and tap [YES].

To edit a playlist transferred from a computer

You cannot edit a playlist transferred from a computer (2) with “Music player”. As an alternative, you can create a new playlist in “Music player” with the same content as the playlist transferred from the computer. That new playlist can be edited.

On the library screen, tap  (Context menu) to the right side of the playlist transferred from the computer (2).

Tap the menu items in the following order.

[Add to another playlist] – [Create new playlist].

Enter the name of the playlist.

For details on how to edit a playlist in “Music player”, see [Managing playlists in “Music player”].

The contents of the Help Guide may be subject to change without notice due to updates to the product's specifications.

Related Topic

- [Transferring content from a Windows computer using Music Center for PC](#)
- [Library screen in “Music player”](#)
- [Managing playlists in “Music player”](#)



Digital Media Player
NW-WM1AM2/NW-WM1ZM2

Managing Favorites in “Music player”

You can add your favorite tracks/albums/playlists to Favorites.
This topic includes instructions for the following operations.

- Adding tracks/albums/playlists to Favorites.
- Listening to tracks/albums/playlists in Favorites.
- Removing tracks/albums/playlists from Favorites.

Adding tracks/albums/playlists to Favorites

1. Perform one of the following.
 - **While “Music player” is playing or pausing a track:**
On the playback screen, tap  (Favorites).
 - **When a list (tracks/albums/playlists) is displayed:**
Tap  (Context menu) to the right side of the item, and then tap [Add to Favorites].

Hint

- You can change the order of items in Favorites. On the favorites screen, tap the menu items in the following order.
 (Options) – [Edit Favorites order].
Drag and drop the reordering icons on the left sides of the items until they are in the desired order.

Note

- You cannot import Favorite information for tracks/albums/playlists to the computer.



Listening to tracks/albums/playlists in Favorites

1. Display the favorites screen.
2. Tap the desired category tab.
3. Tap the desired item.

Hint

- You can play items in Favorites on the library screen as well. On the library screen, tap [Favorites] and tap the desired category, and then tap the desired item.

Removing tracks/albums/playlists from Favorites

1. Perform one of the following.
 - **While “Music player” is playing or pausing a track:**
On the playback screen, tap  (Favorites).
 - **When a list (tracks/albums/playlists) is displayed on the favorites screen:**
Tap  (Context menu) to the right side of the item, and then tap [Remove from this list].

Hint

- You can remove all items from Favorites by category. On the favorites screen, tap the category tab, and then tap the menu items in the following order.
☰ (Options) – [Remove all].

The contents of the Help Guide may be subject to change without notice due to updates to the product's specifications.

Related Topic

- [Playback screen in “Music player”](#)
- [Favorites screen in “Music player”](#)

5-031-748-11(3) Copyright 2022 Sony Corporation

Deleting tracks from “Music player”

- 1 On the library screen in “Music player”, tap the desired category (albums, artists, etc.), and the desired subcategory until a track list appears.

To delete a folder, tap [Folder] and then the desired folder.

- 2 Tap  (Context menu) to the right side of the desired item.

- 3 Tap [Delete].

Hint

- You can also delete music content from the playback screen for “Music player”. Tap the menu items in the following order.
 (Options) – [Delete].
The current track will be deleted from “Music player”.
- You can also delete tracks on a computer using the following applications. For details on operations, refer to the online help information for each application.
 - Windows: Music Center for PC (version 2.4 or later), Windows Explorer

Note

- When you delete tracks using Windows Explorer, do not delete or rename the default folder (such as [Music]). Otherwise, “Music player” will not recognize the content.

The contents of the Help Guide may be subject to change without notice due to updates to the product's specifications.

Related Topic

- [Library screen in “Music player”](#)

Connecting the player to an unpaired Bluetooth device for the first time

The BLUETOOTH® function enables wireless connections between devices. The devices need to support Bluetooth wireless technology. A wireless connection is possible at a range of up to 10 meters (32.8 feet) in an open area. You can listen to music wirelessly by connecting the player to a Bluetooth device such as headphones or speakers. When you connect Bluetooth devices wirelessly for the first time, the devices must be registered to each other. This registration is called “pairing”. Once the player and the device are paired, you can easily connect the devices in the future. The following instructions are a basic step-by-step procedure for connecting the player and a Bluetooth device.

1 Turn on the Bluetooth function on the Bluetooth device.

2 Swipe the [WALKMAN Home] screen upwards on the player.

3 Tap the menu items in the following order.

 [Settings] – [Connected devices] – [Pair new device].

A list of the connectable devices will appear on the screen.

4 Tap the name of the Bluetooth device.

If you are required to enter a passkey while pairing, check and enter the passkey for the Bluetooth device. For details on the passkey for the Bluetooth device, refer to the manual of the device.

When the connection is established, the name of the connected device appears under [Connected devices].

To disconnect from a paired Bluetooth device

Swipe the [WALKMAN Home] screen upwards.

Tap the menu items in the following order.

 [Settings] – [Connected devices].

Tap the settings icon next to the name of the device to disconnect.

Hint

- You can pair the player with only one Bluetooth device at a time. To pair with multiple Bluetooth devices, repeat the procedure in this topic for each device.
- You can erase a registered Bluetooth device. On the list of devices under [Connected devices], tap the settings icon next to the name of the Bluetooth device that you want to erase.
- The passkey may also be called a “passcode”, “PIN code”, “PIN number”, or “password”.
- The player stays connected to the Bluetooth device until you turn off the Bluetooth function. To conserve the battery power, turn off the Bluetooth function or disconnect the player from the paired Bluetooth device.

Note

- Pairing information is deleted in the following situations. Pair the devices again.
 - One or both of the devices are reset to the factory settings.
 - Pairing information is deleted from the devices, such as when the devices are repaired.
- The battery life becomes considerably shorter when the Bluetooth function is active.

- If pairing times out before it is finished, perform the pairing procedure again.
- If sound is interrupted or skips during a Bluetooth connection, try the following.
 - Place the player and the Bluetooth device closer together.
 - Select [SBC-Connection pref.] for [Wireless playback quality].
Swipe the [WALKMAN Home] screen upwards.
Tap the menu items in the following order.
 [Settings] – [Connected devices] – [Connection preferences] – [Bluetooth] – [Wireless playback quality] – [SBC-Connection pref.].
- A Bluetooth connection is terminated automatically in the following cases:
 - The battery of the player has run out.
 - The player is turned off.
- When there is an active Bluetooth connection, the following sound adjustments are disabled.
 - DC Phase Linearizer
 - Vinyl Processor
 - DSD Remastering

Instructional video

There is an instructional video for the following operations.

- Pairing a Bluetooth device for the first time.
- Connecting to a paired Bluetooth device.

Visit the following link.

https://rd1.sony.net/help/dmp/mov0008/h_zz/

The contents of the Help Guide may be subject to change without notice due to updates to the product's specifications.

Related Topic

- [Connecting the player to a paired Bluetooth device](#)
- [Configuring the Bluetooth function](#)
- [Notes on the Bluetooth function](#)

5-031-748-11(3) Copyright 2022 Sony Corporation

Digital Media Player
NW-WM1AM2/NW-WM1ZM2

Connecting the player to a paired Bluetooth device

If the player and a Bluetooth device have been paired before, the Bluetooth device is registered to the player. You can connect the player and the Bluetooth device easily.

- 1 Turn on the Bluetooth function on the Bluetooth device.
- 2 Swipe the [WALKMAN Home] screen upwards on the player.
- 3 Tap the menu items in the following order.
 [Settings] – [Connected devices] – [Connection preferences] – [Bluetooth].
- 4 Tap the Bluetooth switch to turn on the Bluetooth function.

When the Bluetooth function of the player turns on, the player automatically connects to a paired Bluetooth device. If the player does not connect automatically to a Bluetooth device, or if you want to connect to another paired device, go to the next step.
- 5 Swipe the [WALKMAN Home] screen upwards.
- 6 Tap the menu items in the following order.
 [Settings] – [Connected devices].
- 7 Tap the name of the Bluetooth device in the paired device list in [PREVIOUSLY CONNECTED DEVICES].

To turn the Bluetooth function on or off

Swipe the [WALKMAN Home] screen upwards. Then, tap the menu items in the following order.

 [Settings] – [Connected devices] – [Connection preferences] – [Bluetooth].

Then, tap the Bluetooth switch to turn the Bluetooth function on or off.

To confirm the information for a Bluetooth device

Tap the settings icon next to the name of the Bluetooth device.

To erase a registered Bluetooth device

Tap the settings icon next to the name of the Bluetooth device and tap [FORGET].

Follow the onscreen instructions. The pairing information will be erased.

Hint

- You can also turn the Bluetooth function on or off from the Quick Settings panel. On the [WALKMAN Home] screen, swipe down on the status bar twice. Then tap the icon for Bluetooth function in the Quick Settings panel.
- If multiple names for a Bluetooth device are displayed, check the BD address of the Bluetooth device. For details on the BD address, refer to the manual of the Bluetooth device.

- The player stays connected to a Bluetooth device until you turn off the Bluetooth function. To conserve the battery power, turn off the Bluetooth function or terminate the Bluetooth connection with the connected device.

Note

- The battery life becomes considerably shorter when the Bluetooth function is active.
- If sound is interrupted or skips during a Bluetooth connection, try the following.
 - Place the player and the Bluetooth device closer together.
 - Select [SBC-Connection pref.] for [Wireless playback quality].
Swipe the [WALKMAN Home] screen upwards. Then tap the menu items in the following order.
 [Settings] – [Connected devices] – [Connection preferences] – [Bluetooth] – [Wireless playback quality] – [SBC-Connection pref.].
- A Bluetooth connection is terminated automatically in the following cases:
 - The battery of the player has run out.
 - The player is turned off.
- When there is an active Bluetooth connection, the following sound adjustments are disabled.
 - DC Phase Linearizer
 - Vinyl Processor
 - DSD Remastering

Instructional video

There is an instructional video for the following operations.

- Pairing a Bluetooth device for the first time.
- Connecting to a paired Bluetooth device.

Visit the following link.

https://rd1.sony.net/help/dmp/mov0008/h_zz/

The contents of the Help Guide may be subject to change without notice due to updates to the product's specifications.

Related Topic

- [Connecting the player to an unpaired Bluetooth device for the first time](#)
- [Configuring the Bluetooth function](#)
- [Notes on the Bluetooth function](#)

Digital Media Player
NW-WM1AM2/NW-WM1ZM2

Configuring the Bluetooth function

You can select the combination of codecs and preferences for Bluetooth streaming.

- 1 Swipe the [WALKMAN Home] screen upwards on the player.
- 2 Tap the menu items in the following order.
 [Settings] – [Connected devices] – [Connection preferences] – [Bluetooth].
- 3 Tap [Wireless playback quality], and then select the desired item.

Note

- The setting for [Wireless playback quality] will take effect starting the next time the player establishes a Bluetooth connection.
- The setting for [Wireless playback quality] may not be effective depending on the settings of the Bluetooth device.

The contents of the Help Guide may be subject to change without notice due to updates to the product's specifications.

Related Topic

- [Connecting the player to an unpaired Bluetooth device for the first time](#)
- [Connecting the player to a paired Bluetooth device](#)
- [Notes on the Bluetooth function](#)

Digital Media Player
NW-WM1AM2/NW-WM1ZM2

Notes on the Bluetooth function

In this topic, [Bluetooth devices] refers to all Bluetooth-compatible devices.

Bluetooth-compatible devices are audio devices that support the Bluetooth function.

- Depending on the Bluetooth device, network environment, and surrounding conditions, noise may be heard or the sound may be interrupted. To optimize Bluetooth communications, observe the following.
 - Place the player and the Bluetooth device as close together as possible. The Bluetooth standard supports distances of up to 10 meters (32.8 feet).
 - Turn the built-in Bluetooth antenna (aerial) in the direction of the connected Bluetooth device.
 - Do not block the antenna (aerial) with a metal object such as a bag or case.
 - Do not block the antenna (aerial) with a body part such as a hand.
 - Do not block the antenna (aerial) by placing the player inside a backpack or shoulder bag.
 - Do not block the antenna (aerial) by using the player in a crowded place.
 - Avoid areas where electromagnetic waves are emitted. For example, near microwave ovens, mobile phones, or mobile gaming devices.
 - Bluetooth audio equipment and wireless LANs (IEEE 802.11b/g/n) use the same frequency band (2.4 GHz). If you use the player near a device equipped with a wireless LAN, radio-wave interference may occur. It may cause a decrease in connection speed, noise, or connection failure. In this case, take the following measures.
 - When connecting the player to a Bluetooth audio device, keep the player at least 10 meters (32.8 feet) away from any device equipped with a wireless LAN.
 - Keep the player and Bluetooth audio device as close as possible.
 - When using the player within 10 meters (32.8 feet) of a device equipped with a wireless LAN, turn off the power of the wireless LAN.
 - Due to a characteristic of Bluetooth wireless technology, the sound may lag slightly.
 - Bluetooth radiation may affect the operation of electronic medical devices. Turn off the player and other Bluetooth devices in the following locations.
 - in hospitals
 - near priority seats on trains
 - on airplanes
 - in places where flammable gases are present (gas stations, etc.)
 - near automatic doors
 - near fire alarms
 - The player supports security functions that comply with the Bluetooth standard. Sony bears no responsibility whatsoever for information leaks that occur as a result of your Bluetooth connection.
 - Even if a Bluetooth device conforms to the standard, all connections and correct operations are not guaranteed.
 - Depending on the Bluetooth device, it may take some time to establish a Bluetooth connection.
-

The contents of the Help Guide may be subject to change without notice due to updates to the product's specifications.

Related Topic

- [Parts and controls](#)

5-031-748-11(3) Copyright 2022 Sony Corporation

Digital Media Player
NW-WM1AM2/NW-WM1ZM2

Enjoying music content on a computer using the sound quality of the player (USB-DAC function)

You can enjoy the music content on a computer with the same sound quality as the player by connecting the player to the computer via USB. Sound adjustments made on the player also apply to the output sound.

The following applications are compatible with the USB-DAC function. They are recommended for use with the player.

- Windows: Music Center for PC
- Mac: Hi-Res Audio Player for Mac

Note

- While the USB-DAC function is turned on, the player can only be used as a USB-DAC device. To use the player as a music player, turn off the USB-DAC function.
- Music content cannot be transferred while the USB-DAC function is turned on.

1 Install the USB-DAC compatible application on a computer.

- Windows:
 - Music Center for PC: To install the application, access the customer support website. (<https://www.sony.net/smc4pc/>)
 - Sony Audio USB Driver (Windows): Access the customer support website to install Sony Audio USB Driver (Windows). Follow the onscreen instructions.
- Mac:
Hi-Res Audio Player for Mac: Access the customer support website to install the application. Follow the onscreen instructions.

2 On the computer, configure the settings for USB-DAC if necessary.

For details on the settings, refer to the following information.

- Windows: Online help information for Music Center for PC
- Mac: Online help information for Hi-Res Audio Player for Mac on the customer support website.

3 Connect the player to the computer via USB.

4 Confirm the [Use USB for] menu on the player. Select [USB DAC] and tap [OK].

5 On the [WALKMAN Home] screen, tap [Music player].

6 On the library screen in “Music player”, tap [USB DAC].

7 When the start message is displayed, tap [YES].



8 Play music on the computer.

When the input signal is recognized, the lamp in the center of the screen lights up (green or blue) and information on the input signal is displayed.

To adjust the sound

1. Swipe the USB-DAC screen upwards.
The sound adjustment screen will appear.
2. Swipe the screen to the left or right to select a sound adjustment.
3. Adjust the sound by following the onscreen instructions.

Hint

- To turn off the USB-DAC function, tap the ◀ (back) button or tap  (Library top) button. Confirm the end message and tap [YES].
- We recommend connecting the USB Type-C cable to a USB 3.0 port on your computer.
- If the USB-DAC screen goes to the background for reasons such as using another music playback app or video playback app on the player, sound may no longer be output from the headphones.
In this case, you may be able to restore the audio output by returning to the [WALKMAN Home] screen and tapping  [Music player] to display the USB-DAC screen again.

Note

- You cannot listen to played-back sound wirelessly while the USB-DAC function is active.
- The USB-DAC function is designed exclusively for enjoying music. The player processes the audio signals prior to playback. As a result, the audio on the player becomes slightly delayed compared to the computer. This means that images and audio may not be synchronized when you use the USB-DAC function for the following purposes:
 - Playing videos
 - Playing games

Use the USB-DAC function to enjoy music on its own.

The contents of the Help Guide may be subject to change without notice due to updates to the product's specifications.

Related Topic

- [Installing Music Center for PC \(Windows\)](#)
- [USB-DAC screen in “Music player”](#)
- [Adjusting the sound](#)
- [Customer support website](#)

Digital Media Player
NW-WM1AM2/NW-WM1ZM2

USB-DAC screen in “Music player”

You can use the player as a USB-DAC device. Use this function to listen to music content on a computer.

To switch to the USB-DAC function

On the library screen in the “Music player”, tap [USB DAC].

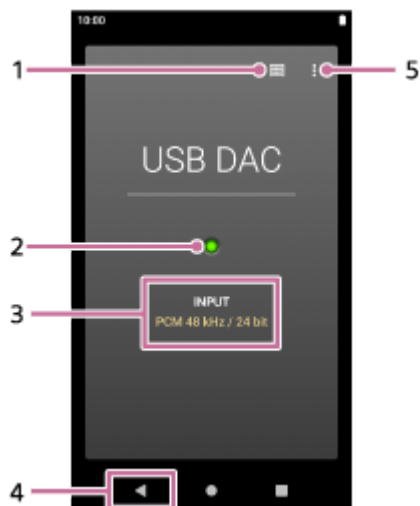

1. Library top button
Tap to turn off the USB-DAC function.
2. Input signal lamp
The lamp indicates the presence and quality of the input signal.
 - Lights up in green: PCM signal
 - Lights up in blue: DSD signal
 - Off: No signal is detected or there is an active Bluetooth connection
3. Sound quality of the input signal (codec, sampling frequency, quantization bit rate)
4. Back button
Tap to turn off the USB-DAC function.
5. Options button

Option menu

Tap  (Options) to display the option menu.

Settings

Select the item to display the Settings menu for “Music player”.

Hint

- Swipe the USB-DAC screen upwards if you want to adjust the sound.

The contents of the Help Guide may be subject to change without notice due to updates to the product's specifications.

Related Topic

- [Enjoying music content on a computer using the sound quality of the player \(USB-DAC function\)](#)

5-031-748-11(3) Copyright 2022 Sony Corporation

Digital Media Player
NW-WM1AM2/NW-WM1ZM2

Adjusting the sound

The player has various settings for adjusting the sound. You can save up to 10 customized sound adjustments as [Saved sound settings]. There are two options to adjust the sound.

- “Sound adjustment” app.
- The sound adjustment screens in “Music player”.

The following are instructions for using “Sound adjustment” app.

- 1 On the [WALKMAN Home] screen, tap  [Sound adjustment].
- 2 Swipe the screen to the left or right to select the sound adjustment.
Be sure to turn off the [Direct Source] beforehand.
- 3 Adjust the sound by following the onscreen instructions.

You can set the following sound adjustment.

- **Direct Source**
This setting outputs the file’s original sound quality directly without applying any sound effects.
Turn on this function to listen to music without processing the audio signals. This will be effective when you enjoy High-Resolution Audio content. On one of the sound adjustment screens, tap the [DIRECT] switch to turn this function on or off.
- **Equalizer**
You can finely adjust the balance of each frequency band as you like.
While the switch is set to [ON], tap [ADJUST] to display the adjustment screen. Then, tap the desired frequency band to adjust it.
- **DSEE Ultimate™**
This function upscales the sound quality of audio files. The sound quality will become almost equal to that of High-Resolution Audio. The function reproduces the clear high-range sound that is often lost.
- **DC Phase Linearizer**
This function adjusts low-frequency phase shifts to reproduce the audio characteristics of analog amplifiers.
Select a sound type for this setting.
- **Dynamic Normalizer**
You can moderate the change in volume between tracks to minimize differences in volume level.
- **Vinyl Processor**
This function produces rich sound that is close to the playback from a vinyl record on a turntable.
Select a sound type for this setting.
- **DSD Remastering**
This function converts a PCM signal to a DSD signal to reproduce sound quality close to analog.
This function is effective only when headphones that support a balance standard connection are connected.

Hint

- Even if you tap the ON/OFF switch of each sound adjustment, the current state will be kept. You can compare the sound while switching the sound adjustments ON and OFF to adjust the settings.
- You cannot select sound adjustments if you have turned on the following settings. Turn off the settings to enable the other sound adjustments.
 - Direct Source
 - DSD Remastering
- Both the “Sound adjustment” app and the sound adjustment screens in “Music player” share adjusted values.

Note

- When there is an active Bluetooth connection, the following sound adjustments are disabled.
 - DC Phase Linearizer
 - Vinyl Processor
 - DSD Remastering
- Sound adjustments are disabled when sound is output from a USB audio device that is connected to the USB Type-C port.

To display the saved sound settings

On one of the sound adjustment screens, tap  (Saved sound settings).

- [Save Saved sound settings]
You can save the current state of the sound adjustments as [Saved sound settings] or overwrite [Saved sound settings] that you have saved with the current state of the sound adjustments.
- [Load Saved sound settings]
You can load or check the [Saved sound settings] that you have saved.

The contents of the Help Guide may be subject to change without notice due to updates to the product's specifications.

Related Topic

- [Sound adjustment screens for “Music player”](#)

Digital Media Player
NW-WM1AM2/NW-WM1ZM2

Using the High-Res streaming function

You can enjoy music streaming from online music services in high sound quality.

- 1 **Swipe the [WALKMAN Home] screen upwards.**
- 2 **Tap the menu items in the following order.**
 -  **[Settings] – [Sound] – [High-Res streaming].**
- 3 **Tap the switch to turn on the [High-Res streaming] function.**

Music streamed using apps other than “Music player” is played in the following quality.

- [Use High-Res streaming] is on:
Up-converted playback at 192 kHz/32 bit
- [Use High-Res streaming] is off:
Down-converted playback at 48 kHz/16 bit

Note

- The [High-Res streaming] function does not support all online music service apps.

The contents of the Help Guide may be subject to change without notice due to updates to the product's specifications.

Digital Media Player
NW-WM1AM2/NW-WM1ZM2

Settings menu in “Music player”

You can adjust the following settings from the Settings menu in “Music player”.

To open the Settings menu, tap the menu items in the following order.

⋮ (Options) – [Settings].

Playback

- Shuffle
- Repeat
 - Repeat off
 - Repeat all
 - Repeat 1 song
- Playback range
 - All range
 - Selected range
- Play on cassette tape screen
- Artist list display
 - Album artist
 - Artist

DSD

- USB output for DSD
 - Auto
 - DoP
- Filtering during DSD playback
 - Slow roll-off
 - Sharp roll-off
- Gain during DSD playback
 - 0 dB
 - -3 dB

Database

- Rebuild database
- Update database

Other

- Audio played
 - Stereo mini:

- Balanced standard:
- Reset settings
- Reset Sound adjustment settings
- About Music player

The contents of the Help Guide may be subject to change without notice due to updates to the product's specifications.

5-031-748-11(3) Copyright 2022 Sony Corporation

Digital Media Player
NW-WM1AM2/NW-WM1ZM2

Restarting the player

Restart the player if operations become unstable.
Restarting will not delete any data and pairing information.

- 1 Hold down the  (power) button () for 2 seconds while the screen is turned on.

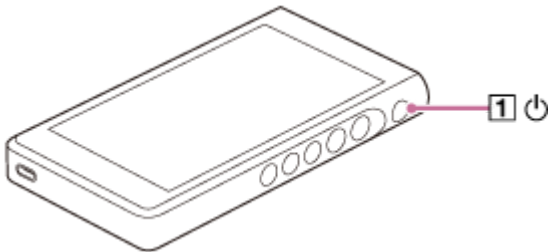

- 2 Tap [Restart].

Hint

- If the player freezes, hold down the  (power) button for 10 seconds to force the player to restart.

The contents of the Help Guide may be subject to change without notice due to updates to the product's specifications.

Related Topic

- [Formatting the player](#)

Digital Media Player
NW-WM1AM2/NW-WM1ZM2

Formatting the player



This operation restores the player to its factory settings. The following data will be deleted.

- Content such as music and photos in the internal memory of the player
- Google Account information on the player
- Downloaded apps

Save a backup copy in advance. Be careful not to delete important data.

- 1** **Swipe the [WALKMAN Home] screen upwards.**
- 2** **Tap the menu items in the following order.**
 **[Settings] – [System] – [Reset options].**
- 3** **Tap [Erase all data (factory reset)].**
- 4** **Confirm the message carefully, and then tap [Erase all data].**
Enter the PIN, password, or pattern if necessary.
- 5** **Confirm the reconfirmation message, and then tap [Erase all data].**
When formatting is complete, the player will restart automatically.

Hint

- When formatting is complete, the player will restore its preinstalled content.
- When you back up a music file from “Music player”, you can check the location of the file. Confirm [File location] under [Detailed song information]. To display the information, tap the menu items in the following order.
 - From the playback screen in “Music player”:
 (Options) – [Detailed song information].
 - From the library screen, play queue screen, or favorites screen in “Music player”:
 (Context menu) – [Detailed song information].

Note

- Sony does not guarantee performance if you format the memory of the player using a computer.

Related Topic

- [Restarting the player](#)

5-031-748-11(3) Copyright 2022 Sony Corporation

Digital Media Player
NW-WM1AM2/NW-WM1ZM2

Formatting a microSD card

You can format a microSD card on the player.

Formatting the microSD card will delete all data stored on the card. Save a backup copy in advance. Be careful not to delete important data.

1 Swipe the [WALKMAN Home] screen upwards.

2 Tap the menu items in the following order.

 [Settings] – [Storage].

3 Tap the name of the microSD card.



4 Tap  (options) in the top right of the screen.

5 Tap the menu items in the following order.

[Storage settings] – [Format].

Confirm the message carefully. Follow the onscreen instructions.

Hint

- When you back up a music file from “Music player”, you can check the location of the file. Confirm [File location] under [Detailed song information]. To display the information, tap the menu items in the following order.
 - From the playback screen in “Music player”:
 (Options) – [Detailed song information].
 - From the library screen, play queue screen, or favorites screen in “Music player”:
 (Context menu) – [Detailed song information].

Note

- When you use a microSD card on the player for the first time, format the microSD card with the player. Otherwise, some functions of the player may be limited.

The contents of the Help Guide may be subject to change without notice due to updates to the product's specifications.

Digital Media Player
NW-WM1AM2/NW-WM1ZM2

Checking information on the player

You can check information such as the model name and system software version.

- 1 Swipe the [WALKMAN Home] screen upwards.
- 2 Tap the menu items in the following order.
 [Settings] – [About device].

The contents of the Help Guide may be subject to change without notice due to updates to the product's specifications.

Related Topic

- [Updating the system software](#)

Digital Media Player
NW-WM1AM2/NW-WM1ZM2



Updating the system software

Update the system software of the player to the latest version. This will allow you to use the most recent functions. Save a backup copy in advance. Be careful not to delete important data.

- 1 **Connect the player to a power source.**
- 2 **Turn on the Wi-Fi function to connect the player to the internet.**
- 3 **Swipe the [WALKMAN Home] screen upwards.**
- 4 **Tap the menu items in the following order.**
 **[Settings] – [System] – [System updates].**

Confirm the message carefully. Follow the onscreen instructions.

Hint

- When you back up a music file from “Music player”, you can check the location of the file. Confirm [File location] under [Detailed song information]. To display the information, tap the menu items in the following order.
 - From the playback screen in “Music player”:
 (Options) – [Detailed song information].
 - From the library screen, play queue screen, or favorites screen in “Music player”:
 (Context menu) – [Detailed song information].

The contents of the Help Guide may be subject to change without notice due to updates to the product's specifications.

Related Topic

- [Charging the battery](#)
- [Connecting the player to a Wi-Fi network](#)
- [Customer support website](#)
- [Checking information on the player](#)

Digital Media Player
NW-WM1AM2/NW-WM1ZM2

Notes on handling the player

Read the notes below and follow the instructions to use the player safely.

- Consult a doctor if you become injured or burned from using the product.
- Contact the nearest Sony dealer or Sony Service Center if the player does not operate properly.
- Observe the following precautions. Otherwise, an explosion, fire, electric shock, burns, or injury may result.
 - Do not expose the player to fire.
 - Do not allow metallic objects to get inside the player.
 - Do not short-circuit the terminals of the player with metallic objects.
 - Do not take apart or modify the player.
 - Do not use the player when you see lightning or hear thunder.
 - Do not use the player if it causes an uncomfortable reaction on your skin.
- Observe the following precautions. Otherwise, you may damage the casing or cause the player to malfunction.
 - Do not place the player in direct sunlight.
 - Do not place the player in locations where the temperature is extremely high.
 - Do not leave the player in direct sunlight. Do not leave the player in a car with all the windows closed, especially during the summer.



- Do not place the player in locations where it is exposed to vibration.
- Do not drop the player from heights.
- Do not apply a strong force or shock to the player.
- Do not place the player in locations where there is magnetization. For example, do not place the player near a magnet, speakers, or a TV.
- Do not turn on the player right after you move it from a cold environment to a warm environment.
- Do not use the player in damp locations, such as in a bathroom or a sauna.
- Do not place the player on an unstable surface or in an inclined position.
- Do not sit down when the player is inserted in your pocket.



- Do not use the player in locations where it is exposed to excessive dust.
- When you store the player in a bag, do not apply strong impacts to the bag. In particular, avoid storing the player in a bag with the headphone cable or earphone cable wrapped around the player.



- Do not place objects on top of the player.

- The player is neither waterproof nor dustproof. Observe the following precautions. Otherwise, the player may become inoperable because of short-circuited terminals or corroded metal.
 - Do not drop the player into water.
 - Do not use the player in humid locations or during wet weather such as rain or snow.
 - Do not place the player against your body or clothes when you are sweating.
 - Do not touch the player with wet hands.



- Comply with announcements regarding the use of electronic devices when you are on an airplane.
- Heat may build up in the player in the following situations, but this is not a malfunction. However, be careful because there is a risk of low-temperature burns.
 - While the battery is charging.
 - While the player is playing for an extended period of time.
- The internal temperature of the player may rise during charging or use. Do not place the player in an airtight bag or wrap the player in cloth when you use the player for a long time. The bag or cloth may trap heat and cause a malfunction.
- Do not apply strong force to the surface of the display. Strong force may cause the following problems.
 - Distorted colors or brightness.
 - A malfunction of the display.
 - Injury from a cracked display.
- When you use the player in a cold location, afterimages may appear on the display. This is not a malfunction.
- The player screen is made of glass. The glass may crack if you drop the player on a hard surface or if you apply strong force to the screen. Be careful when you handle the player. If the glass is cracked or chipped, do not use the player or touch the damaged part. Otherwise, you may get injured.
- Content that you record is for personal use only. Under copyright law, the content cannot be used without the permission of the copyright holder.

The contents of the Help Guide may be subject to change without notice due to updates to the product's specifications.

Digital Media Player
NW-WM1AM2/NW-WM1ZM2

Notes on the headphones

Road safety

Do not use headphones in the following situations.

- While you are driving a car or riding a motorcycle or bicycle.
- Places where impaired hearing is dangerous. For example, on train platforms, in areas where there is vehicle traffic, or near construction sites.

Preventing hearing damage

Observe the following to protect your hearing.

- Keep the volume at a moderate level. Do not listen to audio content at high volumes for an extended period of time.
- Do not turn up the volume suddenly.

About the in-ear headphones

- When you use in-ear headphones with a high degree of adhesion, note the following. Otherwise, you may damage your ears or eardrums.
 - Do not insert the earbuds forcefully into your ears.
 - Do not remove the earbuds from your ears suddenly. When you take off the headphones, move the earbuds up and down gently.
- When you unplug the headphones from the player, hold the headphones by the plug. Pulling the cable itself may damage the headphones.
- Do not sleep while you are wearing headphones. The cable may become wrapped around your neck while you are sleeping.

About the use of headphones with a USB Type-C connector

When you use headphones with a USB Type-C connector, you may not be able to adjust the volume depending on the headphones. This may result in unexpectedly loud volumes from the headphones. To avoid the risk, do not use headphones with a USB Type-C connector.

Consideration for others

Avoid using the player in environments where sound leakage will disturb others.

The contents of the Help Guide may be subject to change without notice due to updates to the product's specifications.

Digital Media Player
NW-WM1AM2/NW-WM1ZM2

Notes on the built-in battery

Do not touch the rechargeable battery with your bare hands if the battery is leaking. The battery liquid may cause burns or blindness. If the liquid contacts your body or clothes, wash the liquid off immediately with clean water.

The contents of the Help Guide may be subject to change without notice due to updates to the product's specifications.

Digital Media Player
NW-WM1AM2/NW-WM1ZM2

Notes on the sample data

Sample music is preinstalled on the player for trial listening.
When formatting is complete, the player will restore its preinstalled content.
Sample data is not installed in some countries or regions.

The contents of the Help Guide may be subject to change without notice due to updates to the product's specifications.

Related Topic

- [Formatting the player](#)

Digital Media Player
NW-WM1AM2/NW-WM1ZM2

General Information

- Charging time and playback time depend on the following conditions.
 - The number of times you have charged the battery
 - Operating temperature
- When the battery is sufficiently charged but the battery life has dropped to about half of its normal span, the battery may be worn out.
- A lithium-ion rechargeable battery is built into the player. When you store the player for long periods of time, check the following to prevent the deterioration of the built-in battery.
 - Store the player at temperatures from 5 °C to 35 °C (41 °F to 95 °F).
 - To prevent deterioration of the battery, charge the battery at least once every 6 months.



- When you use the player in a cold location, the onscreen display may become dark or may not respond quickly. However, these are not malfunctions.
- You feel mild tingling against your ears particularly in dry air conditions. This is a result of static electricity accumulated in the body. This effect can be minimized by wearing clothes made from natural materials.
- Sony is not responsible for user data even if the following problems occur due to defects in the player or a computer.
 - Recording or downloading of data is incomplete.
 - Data (such as music) is damaged or deleted.
- Internet Connection and IP address
Technical data such as IP address [or device details] is used when this product is connected to the internet for software update or receiving third party services. For software updates, these technical data may be communicated to our update servers in order to provide you with the software update appropriate to your device. If you do not want such technical data be used at all, do not set-up the wireless internet function and do not connect an internet cable.

The contents of the Help Guide may be subject to change without notice due to updates to the product's specifications.

Digital Media Player
NW-WM1AM2/NW-WM1ZM2

Maintenance

- Clean the player with a soft cloth, such as a cleaning cloth for eyeglasses.
- To clean a player that has gotten very dirty, use a cloth slightly moistened with a mild detergent solution. Be careful not to get water inside the player.
- Do not clean with solvents such as alcohol, naphtha, or paint thinner. These solvents may damage the surface of the player.
- Clean the headphone plug occasionally with a soft dry cloth. Noise or sound skipping may occur if the plug is dirty.
- (NW-WM1ZM2 only)
This product contains gold plating with purity of about 99.7 % gold. Wipe gently without rubbing strongly when you clean the product. The gold-plated parts are more sensitive than regular plated parts. When you clean the product, Sony recommends working on a tabletop covered with a soft cloth to prevent scratches.

The contents of the Help Guide may be subject to change without notice due to updates to the product's specifications.

Digital Media Player
NW-WM1AM2/NW-WM1ZM2

Customer support website

Visit the customer support website in your country or region in the following situations.

- When you have a question about the player.
- When you have an issue with the player.
- When you want information on compatible items.

For customers in the USA, Canada and Latin America:

<https://www.sony.com/am/support>

For customers in Europe:

<https://www.sony.eu/support/>

For customers in Mainland China:

<https://service.sony.com.cn/>

For customers in Asia-Pacific, Oceania, the Middle East and Africa:

<https://www.sony-asia.com/support>

For customers who purchased the overseas models:

<https://www.sony.co.jp/overseas/support/>

The contents of the Help Guide may be subject to change without notice due to updates to the product's specifications.

Digital Media Player
NW-WM1AM2/NW-WM1ZM2

Specifications

Display

Size

12.7 cm (5.0-inch)

Resolution

HD (1280 × 720 Pixels)

Panel type

TFT color display with white LED-backlight

Touch panel

Supported

Interface

USB

Type-C (USB 3.2 Gen1 compliant)

Headphone

Stereo mini jack, Balanced standard jack

External memory

microSD, microSDHC, microSDXC

Wireless LAN

Standard

IEEE 802.11a/b/g/n/ac

Frequency band

2.4/5 GHz band

Encryption

WEP/WPA/WPA2

Bluetooth

Version

Communication system: Bluetooth Specification Version 5.0

Frequency band

2.4 GHz band (2.4000 GHz - 2.4835 GHz)

Modulation method

FHSS

Supported Bluetooth profiles

A2DP, AVRCP, SPP, OPP, DID

Supported Codecs (Transmission)

SBC, LDAC, aptX, aptX HD, AAC

Sensor

Accelerometer

Microphone

Monaural

Headphone Out (Stereo mini jack)

Frequency response

20 Hz - 40,000 Hz

Headphone Out (Balanced standard jack)

Frequency response

20 Hz - 40,000 Hz

General

Power Source

Built-in battery: Built-in Rechargeable lithium-ion Battery

Charging and Power supply: USB power (from a computer via a USB)

Charging Time (USB charging)

Approx. 4.5 hours

Operating temperature

5 °C to 35 °C (41 °F to 95 °F)

Dimensions

w/h/d, projecting parts not included

NW-WM1AM2: Approx. 75.6 mm × 141.4 mm × 20.8 mm (2.98 inches × 5.57 inches × 0.82 inches)

NW-WM1ZM2: Approx. 75.6 mm × 141.4 mm × 20.8 mm (2.98 inches × 5.57 inches × 0.82 inches)

w/h/d

NW-WM1AM2: Approx. 80.5 mm × 142.5 mm × 20.8 mm (3.17 inches × 5.62 inches × 0.82 inches)

NW-WM1ZM2: Approx. 80.5 mm × 142.5 mm × 21.0 mm (3.17 inches × 5.62 inches × 0.83 inches)

Mass

NW-WM1AM2: Approx. 299 g (10.55 oz)

NW-WM1ZM2: Approx. 490 g (17.29 oz)

Capacity

Capacity

NW-WM1AM2: 128 GB

NW-WM1ZM2: 256 GB

Actual available memory for other contents

NW-WM1AM2: Approx. 103 GB

NW-WM1ZM2: Approx. 215 GB

Note

- Available capacity may vary. A portion of the memory is used for data management functions.
- When you update the system software, reserve about 2 GB of free space in the internal shared storage.

Leather case (NW-WM1ZM2 only)

Dimensions (w/h/d)

Approx. 88.3 mm × 151.3 mm × 30.3 mm (3.48 inches × 5.96 inches × 1.20 inches)

Mass

Approx. 121 g (4.27 oz)

The contents of the Help Guide may be subject to change without notice due to updates to the product's specifications.

5-031-748-11(3) Copyright 2022 Sony Corporation

Digital Media Player
NW-WM1AM2/NW-WM1ZM2

Battery life

Music (when using “Music player”)

Stereo mini jack

MP3 (128 kbps)

Approx. 40 hours

AAC (256 kbps)

Approx. 40 hours

WAV (44.1 kHz/16 bit)

Approx. 40 hours

FLAC (44.1 kHz/16 bit)

Approx. 40 hours

FLAC (96 kHz/24 bit)

Approx. 40 hours

FLAC (192 kHz/24 bit)

Approx. 35 hours

DSD (2.8224 MHz/1 bit)

Approx. 25 hours

DSD (5.6448 MHz/1 bit)

Approx. 18 hours

DSD (11.2896 MHz/1 bit)

Approx. 15 hours

Balanced standard jack

MP3 (128 kbps)

Approx. 40 hours

AAC (256 kbps)

Approx. 40 hours

WAV (44.1 kHz/16 bit)

Approx. 40 hours

FLAC (44.1 kHz/16 bit)

Approx. 40 hours

FLAC (96 kHz/24 bit)

Approx. 40 hours

FLAC (192 kHz/24 bit)

Approx. 35 hours

DSD (2.8224 MHz/1 bit)

Approx. 15 hours

DSD (5.6448 MHz/1 bit)

Approx. 13 hours

DSD (11.2896 MHz/1 bit)

Approx. 9 hours

Music (when using a music app other than “Music player”)

Stereo mini jack

MP3 (128 kbps)

Approx. 18 hours

Balanced standard jack

MP3 (128 kbps)

Approx. 18 hours

Bluetooth (when using “Music player”)

MP3 (128 kbps)/SBC-Connection pref.

Approx. 20 hours

FLAC (96 kHz/24 bit)/LDAC-Connection pref.

Approx. 18 hours

Bluetooth (when using a music app other than “Music player”)

MP3 (128 kbps)/LDAC-Connection pref.

Approx. 17 hours

A Bluetooth connection will shorten the battery life by up to 60% depending on the following conditions.

- Format of the content.
- Settings of the connected device.

Note

- The values shown in this topic indicate the approximate battery life when the player is playing continuously with the default settings.
- Even if the player is turned off for an extended period, a small amount of battery power is still consumed.
- Battery life may vary depending on volume setting, conditions of use and ambient temperature.
- The battery is consumed considerably when the screen is on.
- The battery life may become about 60% shorter when some of the sound adjustments are active.
- The battery life may become about 20% shorter when the [High-Res streaming] function is active.

The contents of the Help Guide may be subject to change without notice due to updates to the product's specifications.

Digital Media Player
NW-WM1AM2/NW-WM1ZM2

Maximum recordable number of songs

NW-WM1AM2 (128 GB)

MP3 (128 kbps)

Approx. 20,000 songs

AAC (256 kbps)

Approx. 14,000 songs

FLAC (44.1 kHz/16 bit)

Approx. 2,500 songs

FLAC (96 kHz/24 bit)

Approx. 780 songs

FLAC (192 kHz/24 bit)

Approx. 390 songs

DSD (2.8224 MHz/1 bit)

Approx. 640 songs

NW-WM1ZM2 (256 GB)

MP3 (128 kbps)

Approx. 20,000 songs

AAC (256 kbps)

Approx. 20,000 songs

FLAC (44.1 kHz/16 bit)

Approx. 5,300 songs

FLAC (96 kHz/24 bit)

Approx. 1,630 songs

FLAC (192 kHz/24 bit)

Approx. 810 songs

DSD (2.8224 MHz/1 bit)

Approx. 1,330 songs

Note

- The approximate numbers are based on 4 minute a song.
- This product is confirmed to operate normally with up to a total of 20,000 tracks stored in the main memory and on the microSD card.

The contents of the Help Guide may be subject to change without notice due to updates to the product's specifications.

Digital Media Player
NW-WM1AM2/NW-WM1ZM2

Supported formats

Music

MP3 (.mp3)

32 kbps - 320 kbps (Supports variable bit rate (VBR)) / 32 kHz, 44.1 kHz, 48 kHz

WMA (.wma)

32 kbps - 192 kbps (Supports variable bit rate (VBR)) / 44.1 kHz

FLAC (.flac)

16 bit, 24 bit / 8 kHz - 384 kHz

WAV (.wav)

16 bit, 24 bit, 32 bit (Float/Integer) / 8 kHz - 384 kHz

AAC (.mp4, .m4a, .3gp)

16 kbps - 320 kbps / 8 kHz - 48 kHz

HE-AAC (.mp4, .m4a, .3gp)

32 kbps - 144 kbps / 8 kHz - 48 kHz

Apple Lossless (.mp4, .m4a)

16 bit, 24 bit / 8 kHz - 384 kHz

AIFF (.aif, .aiff, .afc, .aifc)

16 bit, 24 bit, 32 bit / 8 kHz - 384 kHz

DSD (.dsf, .dff)

1 bit / 2.8224 MHz, 5.6448 MHz, 11.2896 MHz

APE (.ape)

8 bit, 16 bit, 24 bit / 8 kHz - 192 kHz (Fast, Normal, High)

MQA (.mqa.flac)

Supported

Note

- Sampling frequency may not correspond to all encoders.
- Copyright protected files cannot be played back.
- Non-standard bit rates or non-guaranteed bit rates are included depending on the Sampling frequency.
- Files that are 4 GB (APE is 2 GB) or larger cannot be played back.
- This product recognizes audio sources exceeding CD quality (44.1 kHz/16 bit quantization) and DAT quality (48 kHz/16 bit quantization) as High-Resolution Audio. The "HR" symbol is displayed for High-Resolution Audio.

The contents of the Help Guide may be subject to change without notice due to updates to the product's specifications.

Digital Media Player
NW-WM1AM2/NW-WM1ZM2

System requirements

A Wi-Fi environment is required to use some features of this product.

Compatible application software

- Music Center for PC
Please check the supported OS from the support page.
- Additional software is required to operate on a Mac.

The contents of the Help Guide may be subject to change without notice due to updates to the product's specifications.