

# LINA Headphone Amplifier

## User Guide

## Your guide to LINA

This User Guide is designed to help you experience the full potential of your dCS LINA Headphone Amplifier.

Inside, you'll find advice on how to set up, install, use and care for your system. We ask that you read it carefully before getting started. If you require further information or support, you can contact us at [dcsaudio.com/contact](https://dcsaudio.com/contact).

We hope you enjoy listening, and are delighted to welcome you to the dCS community.

## Document information

Published on: 16/03/2022

Document ID: DCS320671 - Rev1.0

## Copyright

Copyright © 2022 Data Conversion Systems Ltd. All Rights Reserved.

Information contained in this manual is subject to change without notice, and whilst it is checked for accuracy, no liabilities can be accepted for errors.

dCS is Data Conversion Systems Ltd. Company registered in England No. 2072115.

dCS is a registered trademark of Data Conversion Systems Ltd.

Other product and company names may be trademarks or registered trademarks of other companies, and are the property of their owners. They are used only for explanation, without intent to infringe.

## Intended purpose

This document advises users how to set up, use and configure the product.

## Conventions in this document

This document uses the following safety notices and tips:



### **WARNING**

Indicates a hazardous situation which, if not avoided, could result in death or serious injury.



### **CAUTION**

Indicates a hazardous situation which, if not avoided, could result in moderate injury, damage the product, or lead to loss of data.

### **NOTICE**

Indicates an important situation which, if not avoided, may seriously impair operations.



Additional information relating to the current section.

# Contents

<b>Safety</b>	<b>5</b>
<b>Getting started</b>	<b>7</b>
What's in the box	7
Where to place the LINA Headphone Amplifier	7
Recommended cables and connectors	7
<b>Overview</b>	<b>9</b>
Front	9
Rear	10
<b>Setting up</b>	<b>11</b>
Connecting the power supply	11
Switching the unit on and off	11
Connecting the LINA range	12
Connecting inputs	14
Connecting headphones	14
Using Power Link	15
<b>Using the LINA Headphone Amplifier</b>	<b>16</b>
Changing the source input	16
Changing the volume	16
Changing the gain	16
<b>Maintenance</b>	<b>17</b>
Replacing a blown mains fuse	17
Cleaning the unit	18
<b>Specifications</b>	<b>19</b>
<b>Support</b>	<b>20</b>
<b>Limited warranty</b>	<b>21</b>
General information	21
Warranty exclusions	21
Obtaining service	22
Operating conditions	22
<b>Compliance</b>	<b>23</b>
Product label	23
FCC compliance statement	24
EU Declaration of Conformity	24
Korea Class B compliance statement	25

# Safety

To prevent personal injury or damage to the unit, read the following safety messages before use.



## CAUTION

Read and comply with all safety messages and instructions in this document.

- Follow the cleaning instructions in this document.
- Only install the unit according to the instructions in this document.
- Do not spill liquid on the unit or allow it to get wet.
- Do not install the unit near heat sources.
- Use only the attachments and accessories specified by dCS.



## CAUTION

To prevent possible hearing damage, do not listen at high volume levels for long periods of time. Prolonged exposure to high volumes when using headphones may damage your hearing.



## CAUTION

To prevent the risk of electric shock and ensure the best audio performance, connect the unit to mains earth (ground) using the correct power cable.

- A grounding type plug has two blades and a grounding prong, which is provided for safety. If the provided plug does not fit into your outlet, contact a qualified electrician.
- Do not use the power cable if it is damaged.
- If this unit is not being used for a long period of time, disconnect the unit from the power supply.
- During lightning storms, disconnect the unit from the power supply to prevent power surges.



## CAUTION

The safety covers on the unit protect you from electric shock.

- Do not remove the safety covers from the unit.
- If you do remove the safety covers from the unit, it invalidates the warranty.



#### **NOTICE**

If the unit is damaged, do not use it and contact a qualified service engineer. Possible causes of damage to the unit include the following:

- Liquid is spilled on the unit.
- A heavy object falls on the unit.
- The unit is exposed to rain or moisture.
- The unit is dropped.

#### **NOTICE**

Damage caused to the unit by misuse of a mains regenerator or by a malfunctioning mains regenerator is not covered by the warranty.

- We do not recommend the use of mains regenerators.
- If you want to use a mains regenerator with variable voltage and frequency, set the voltage to match your local voltage. Set the frequency to either 50Hz or 60Hz.
- Do not change the output voltage of the mains generator while it is connected to the unit.

#### **NOTICE**

If the unit is cold and is moved into a warm room, condensation may form inside the unit. Condensation may interfere with the normal operation of the unit. If the unit has been kept somewhere cold, remove all packaging and leave it for 1-2 hours before using it to allow it to reach room temperature.

# Getting started

## What's in the box

The box contains the following items:

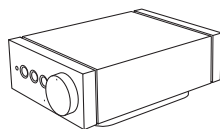

dCS LINA Headphone Amplifier

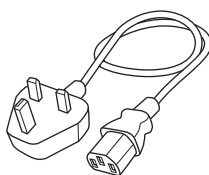

Power cable (2m)

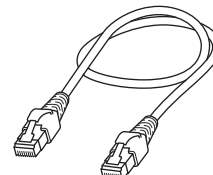

Power Link cable (0.5m)



Getting Started Guide



Welcome letter

If an item is missing from the box, contact your fulfilment centre.



We recommend that you keep the original packaging of the unit. If you need to order replacement packaging, contact your fulfilment centre.

## Where to place the LINA Headphone Amplifier

To get the best sound quality:

- You can stack units vertically or place them next to each other.
- Ensure you can easily connect LINA Headphone Amplifier to other units of your system.
- If units are stacked vertically, place the bottom unit on a firm, vibration-free base.



To prevent overheating, we recommend that you leave some space around the units to allow for ventilation.

## Recommended cables and connectors

We recommend the following cables and connectors for use with the unit. We supply "commercial" cables with the unit, but you can use cables and connectors of your preferred quality.

### NOTICE

Heavy or inflexible power cables may damage the power socket on the unit.



Some “audiophile” cables have unusual grounding or screening arrangements, or they don't have the correct characteristic impedance. If you have difficulty using such cables but the problem disappears when you use standard cables, contact your cable manufacturer.

<b>Input</b>	<b>Recommended cable and connector</b>
Balanced input	Screened, twisted pair cables fitted with one male 3 way XLR connector and one female 3 way XLR connector.
Unbalanced inputs	Coax cables fitted with RCA phono connectors.



# Overview

## Front

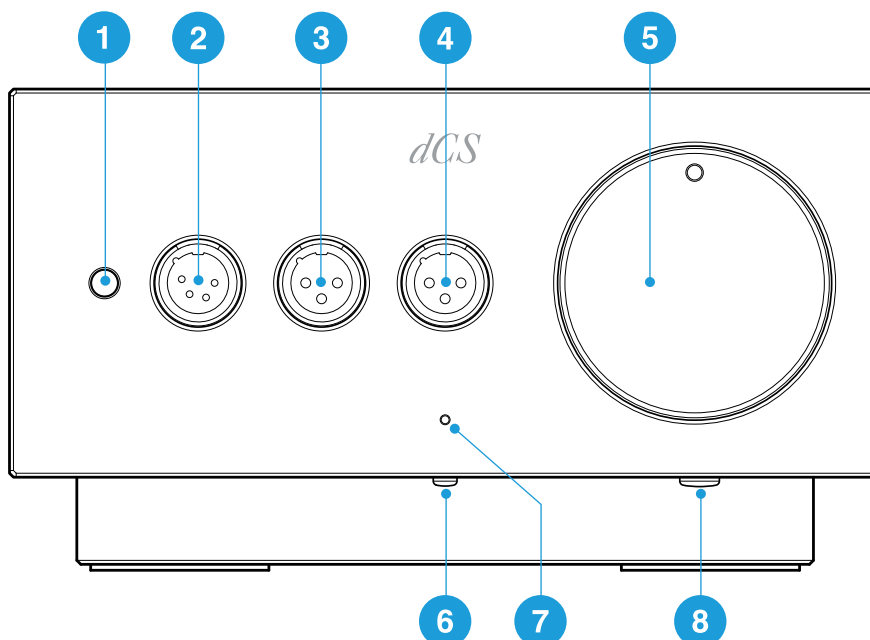

Item	Description
1	¼ " (6.35 mm) jack output Connect headphones.
2	4-pin balanced XLR output Connect headphones.
3	3-pin balanced XLR output (left channel) Connect headphones (for use together with item 4).
4	3-pin balanced XLR output (right channel) Connect headphones (for use together with item 3).
5	Rotary control Turn to change the volume.
6	Power / Input button When the unit is switched off, press to switch it on. When the unit is switched on, press to change input. When the unit is switched on, press and hold for 2 seconds to switch it off.
7	Status indicator When the unit is on, the status indicator is bright white, blue or magenta depending on the input. ▶ For more information, see "Changing the source input" on page 16.
8	Gain selection switch Select the required gain. ▶ For more information, see "Changing the gain" on page 16.

## Rear

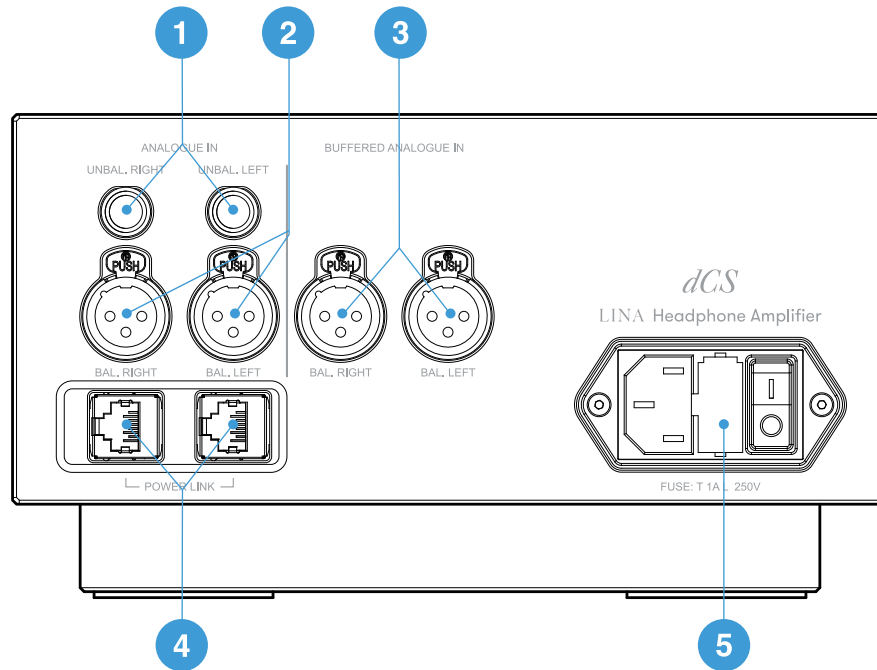

Item	Description
1 UNBAL. RIGHT UNBAL. LEFT	Unbalanced RCA analogue inputs. Connects the unit to an audio source.
2 BAL. RIGHT BAL. LEFT	Balanced XLR analogue inputs. Connects the unit to an audio source.
3 BAL. RIGHT BAL. LEFT	Buffered, balanced XLR analogue inputs. Connects the unit to an audio source.
4 POWER LINK	RJ45 input. Connects the unit to other LINA units to enable Power Link. ► For more information, see "Using Power Link" on page 15.
5 Power socket, fuse, and power switch	Power is connected via a standard IEC320 connector, with a power switch and a fuse holder.

### Analogue inputs

Connect source equipment with unbalanced outputs to the unbalanced inputs.

Connect source equipment with balanced outputs to either of the balanced inputs. The unbuffered inputs are intended to be connected to the LINA Network DAC, but they can be used with other equipment. The connections are:

- Pin 1: Screen / ground
- Pin 2: Signal +
- Pin 3: Signal -

# Setting up

## Connecting the power supply

Use the supplied power cable to connect your LINA Headphone Amplifier to the power supply.

1. At the rear of the unit, insert the power cable into the power socket.
2. Connect the plug to a power supply.

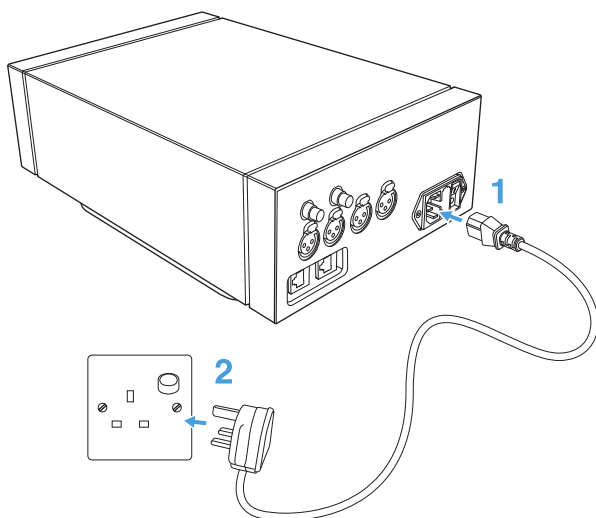

## Switching the unit on and off

At the rear of the unit, there is a power rocker switch next to the power cable. There is also a power button on the front panel.

To switch on the unit:

1. On the rear of the unit, press the power rocker switch to the / position.

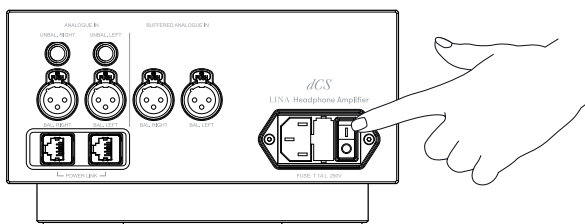

2. On the front of the unit, press the *Power / Input* button.

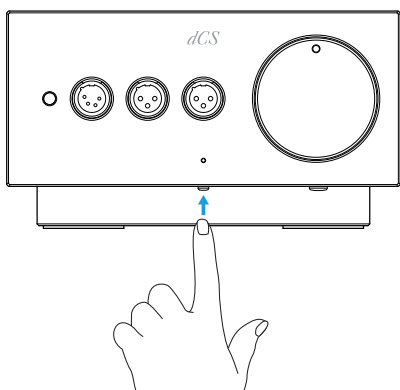

To switch off the unit:

- Press and hold the *Power / Input* button for 2 seconds.

## Connecting the LINA range

To connect the LINA Network DAC, LINA Master Clock and LINA Headphone Amplifier together:

1. Position the LINA range.
2. Connect the LINA Network DAC to the LINA Headphone Amplifier.
3. Connect the LINA Master Clock to the LINA Network DAC.

### 1. Positioning the LINA range

You can position the units in one of the following ways:

- Place the units side by side.
- Stack the units vertically in the following order:
  - LINA Headphone Amplifier at the bottom
  - LINA Master Clock in the middle
  - LINA Network DAC on top



To prevent overheating, we recommend that you leave some space around the units to allow for ventilation.

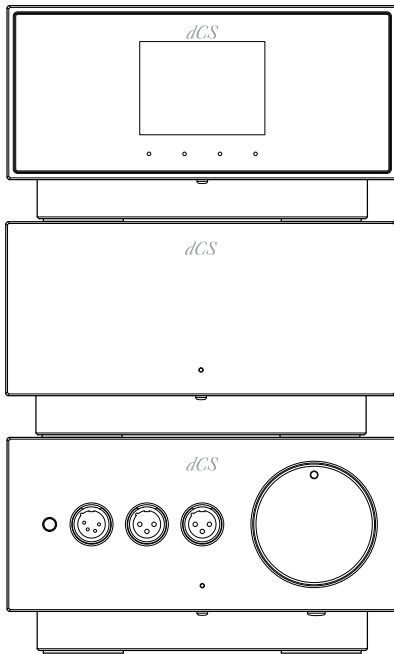

### 2. Connecting the LINA Network DAC to the LINA Headphone Amplifier

You can connect the LINA Network DAC to the LINA Headphone Amplifier using the balanced XLR sockets.

1. Using two balanced XLR cables, connect the *BAL. LEFT* and *BAL. RIGHT* outputs on the LINA Network DAC to the *BAL. LEFT* and *BAL. RIGHT* inputs on the LINA Headphone

## Amplifier.

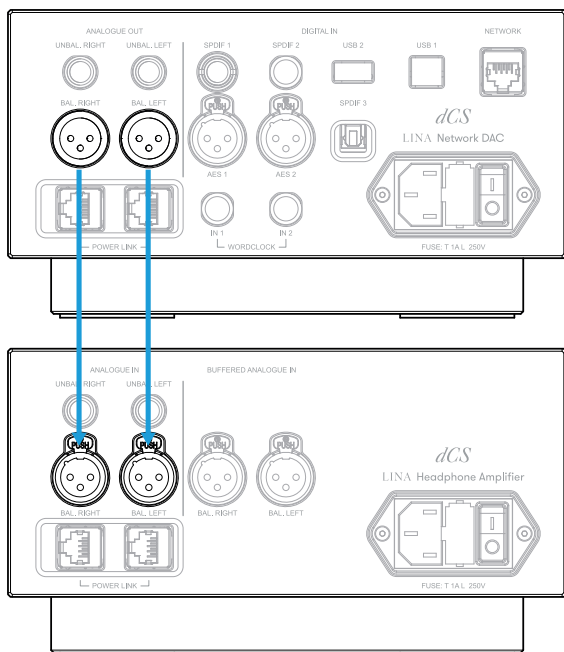



2. On the LINA Headphone Amplifier, choose the unbuffered XLR input. If the status indicator is not white, press the *Power / Input* button until it changes to white.
  - ▶ For more information, see "*Changing the source input*" on page 16.

## 3. Connecting the LINA Master Clock to the LINA Network DAC

You can lock the network and USB inputs on the LINA Network DAC to the LINA Master Clock.

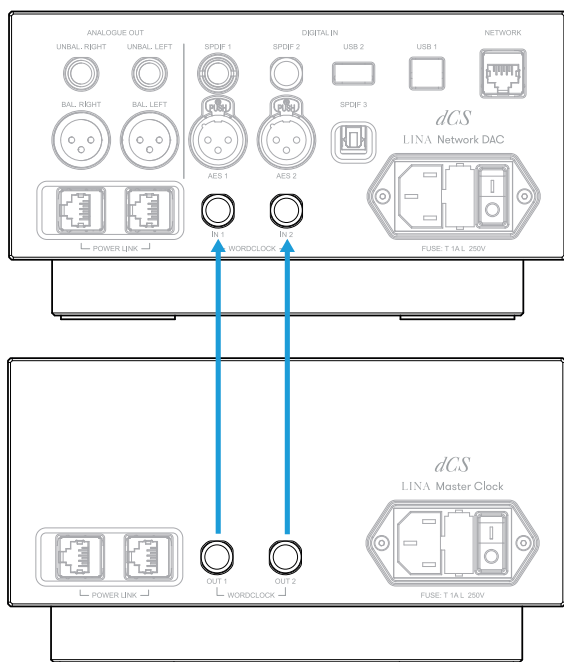
1. Switch on the LINA Network DAC and the LINA Master Clock.
2. On the LINA Network DAC, choose the network or USB input.
3. Using two BNC cables, connect the *WORDCLOCK* output sockets on the LINA Master Clock to the *WORDCLOCK* input sockets on the LINA Network DAC.



4. Set the clocking sync mode on the LINA Network DAC to Auto . The LINA Network DAC selects the appropriate clock input and locks to it.



If you lock an AES or SPDIF input on the LINA Network DAC to the LINA Master Clock, the source equipment will not be locked to the Clock, resulting in periodic clicks, dropouts or distortion.

To use the LINA Network DAC in this way, use source equipment that has a word clock input and a Master Clock with extra outputs.

## Connecting inputs

You can use the input sockets on the LINA Headphone Amplifier to connect source audio equipment, such as DACs.

1. At the rear of the LINA Headphone Amplifier, connect suitable cables.
  - If you are using the balanced inputs, connect XLR cables to the *BAL. LEFT* and *BAL. RIGHT* sockets.
  - If you are using the unbalanced inputs, connect RCA phono cables to the *UNBAL. LEFT* and *UNBAL. RIGHT* sockets.

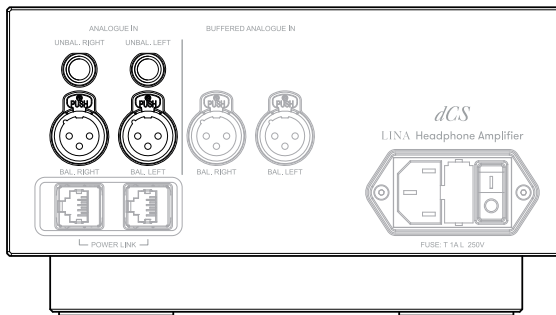

2. Connect the other end of the cables to the source equipment.
3. Switch on the source equipment.
4. If possible, play music on the source equipment to generate an audio signal.
5. Change the source input on the unit.
  - ▶ *For more information, see "Changing the source input" on page 16.*

## Connecting headphones

You can connect headphones to the sockets on the front of the unit.

- ▶ *For more information, see "Front" on page 9.*



Before connecting headphones to the unit, turn down the volume.

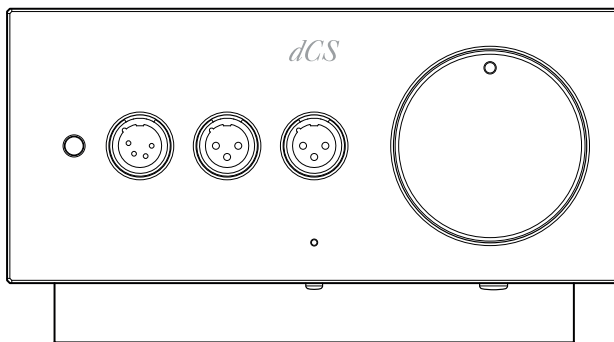

## Using Power Link

Power Link allows you to switch LINA units on and off at the same time, or put the LINA Network DAC and LINA Master Clock in and out of sleep mode at the same time.

To enable Power Link, use two RJ45 cables to connect the *POWER LINK* sockets on each unit.

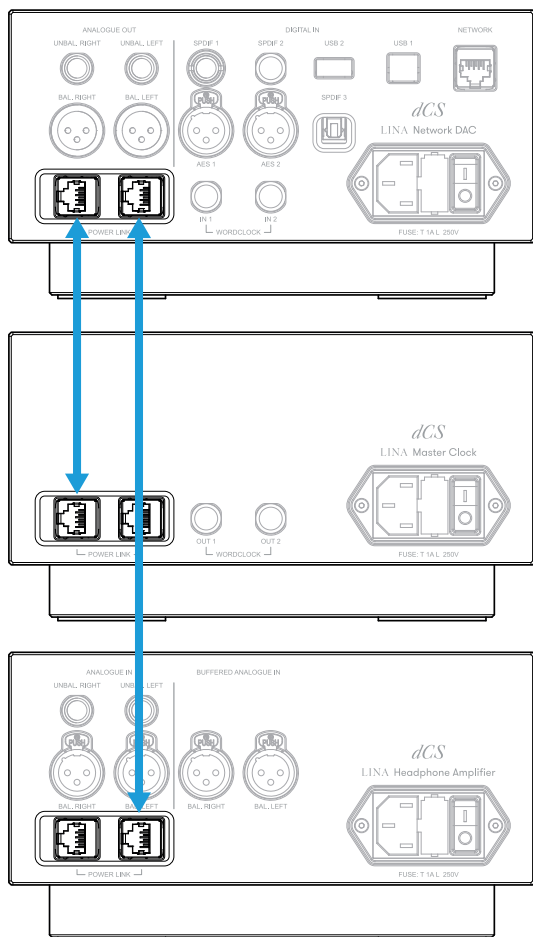

# Using the LINA Headphone Amplifier

## Changing the source input

To change the source input, press the *Power / Input* button on the front of the unit. The status indicator colour shows the current input.

Status indicator colour	Input
White	Balanced XLR. Recommended when connecting the unit to the LINA Network DAC.
Blue	Buffered, balanced XLR
Magenta	Unbalanced RCA

## Changing the volume

To change the volume, turn the rotary control on the front of the unit.

## Changing the gain

You can set the amplifier gain to suit the sensitivity of your headphones. The gain switch is under the volume rotary control, and has 2 positions:

- To make music quieter, slide the switch to the left to *Low Gain*.
- To make music louder, slide the switch to the right to *High Gain*.

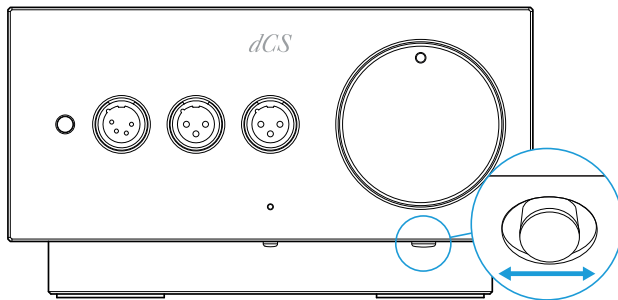



# Maintenance

dCS audio products do not need regular maintenance. The only user-serviceable part of the unit is the mains fuse. If the unit is damaged, contact your fulfilment centre.

## Replacing a blown mains fuse

There is a fuse within the unit's power inlet. If the fuse blows, you can replace it.

- If the fuse blows once, replace the fuse. There was a power surge.
- If the fuse blows repeatedly, contact your fulfilment centre to arrange repair. There is a fault in the unit.

Fuse type: 20 x 5 mm, T 1A L / 250 V



### WARNING

Replace the fuse with one of the same type and rating. If you use a fuse of a different type or rating, it may damage the unit and there is a risk of fire or electric shock. It also invalidates the warranty.

To replace a blown mains fuse:

1. Unplug the power cable from the unit.
2. Next to the power rocker switch, push the two tabs of the fuse holder towards the centre and pull out the fuse holder.

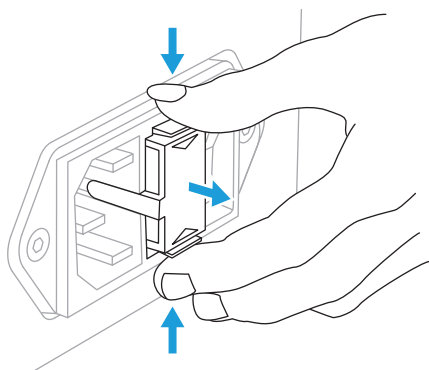

3. Remove the blown fuse from the lower position of the fuse holder.

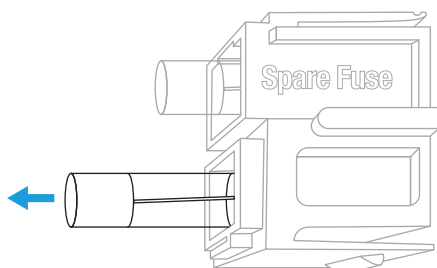

4. Replace the blown fuse with the spare fuse from the upper position.

5. Push the fuse holder back into the unit with the writing the correct way up, until you hear a click.

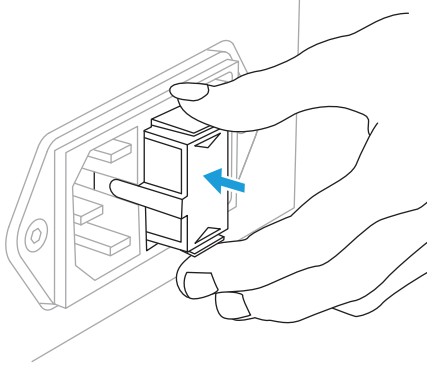

## Cleaning the unit

If the case of the unit gets dusty or dirty, you can clean it with a lint-free cloth.

- To remove fingerprints and loose dust, use a clean and dry lint-free cloth.
- To clean any other surfaces, use a small amount of glass cleaner containing ammonia and a lint-free cloth. Do not spray glass cleaner directly onto the connector contacts.

# Specifications

<b>Inputs</b>	1x stereo pair unbalanced RCA, input impedance 48 k $\Omega$ 1x stereo pair unbuffered balanced XLR, input impedance 24 k $\Omega$ 1x stereo pair buffered balanced XLR, input impedance 96 k $\Omega$
<b>Outputs</b>	1x dual 3-pin balanced XLR, right and left channel 1x single 4-pin balanced XLR 1x single ¼ " (6.35 mm) headphone jack
<b>Headphone impedance</b>	8 $\Omega$ to 600 $\Omega$
<b>Headphone output impedance</b>	< 0.090 $\Omega$
<b>Frequency response</b>	1 Hz - 100 kHz Better than +0/-3 dB
<b>THD+N</b>	<0.005% @ 1 kHz 6 V rms balanced output into 30 $\Omega$ (80 kHz bandwidth)
<b>Channel separation</b>	Balanced input to balanced output into 30 $\Omega$ . Better than 100 dB @ 1 kHz. Better than 80 dB, 20 Hz – 20 kHz.
<b>Signal-to-noise ratio</b>	110 dB 20 Hz - 20 kHz A-weighted (referenced to 6 V rms balanced input and output)
<b>Volume control</b>	Analogue rotary control
<b>Power Link</b>	2x RJ45
<b>Shipping dimensions</b>	320 mm (H) x 360 mm (W) x 530 mm (D)
<b>Shipping weight</b>	10 kg
<b>Product dimensions</b>	121.5 mm (H) x 220 mm (W) x 356 mm (D)
<b>Product weight</b>	7.5 kg
<b>Power output</b>	Balanced 2 W into 30 $\Omega$ Balanced 0.48 W into 300 $\Omega$ Unbalanced 1.6 W into 30 $\Omega$ Unbalanced 0.2 W into 300 $\Omega$
<b>Power requirements</b>	90-120 V / 220-240 V, 50/60 Hz Power consumption: 30 W



These specifications are subject to change without notice.

# Support

If you need help using your LINA Headphone Amplifier, contact your fulfilment centre for assistance, quoting the serial number of your unit.

Manufactured by:

Data Conversion Systems Ltd.  
Unit 1, Buckingham Business Park,  
Anderson Road,  
Swavesey,  
Cambridgeshire,  
CB24 4AE,  
UK

[www.dcsaudio.com](http://www.dcsaudio.com)

# Limited warranty

## General information

dCS warrants this product against defects in materials and workmanship for a period of 3 years from the date the unit was originally shipped from dCS. If the product is purchased and registered with dCS within 6 months of the date the unit was originally shipped from dCS, we will start the warranty on the purchase date. For units registered later than 6 months from the ship date, we will start the warranty from the ship date unless the registration is supported by the original sales invoice. During the first year of the warranty period, dCS will repair or, at our absolute discretion, replace a faulty product. For the remaining two years, service will be covered, but any parts needed will be chargeable. Warranty repairs must only be carried out by dCS or our authorised service agents. Please contact your fulfilment centre if your unit requires service.

To register this product, either register online at [www.dcsaudio.com/register](http://www.dcsaudio.com/register) or complete the Product Registration form within 30 days of the sale and return it to dCS. On receipt of the registration, dCS will add your contact details to our customer database. dCS will use this information for warranty purposes only, we will not contact you directly for reasons relating to sales and marketing.

This warranty applies to the original owner, it is not transferable.

## Warranty exclusions

The warranty does not cover wear and tear.

The warranty on this product will be void if:

- the product is misused in any way.
- any unauthorised modifications or repairs are carried out.
- the product is not used in accordance with the Operating Conditions stated in this manual.
- the product is serviced or repaired other than by dCS or our authorised service agents.
- the product is operated without a mains earth (or ground) connection.
- the unit is returned inadequately packed.

dCS reserve the right to apply a service charge if a product returned for warranty repair is found to be operating correctly, or if a product is returned without a returns number being issued.

This warranty covers parts and labour only, it does not cover shipping charges or tax/duty.

Our fulfilment centres and service agents are not authorised to extend the terms of this warranty, dCS cannot accept responsibility for any attempt to do so.

Products re-sold by dCS on a “used” basis may be subject to reduced warranty terms.

## Obtaining service

Should you encounter a problem, contact your fulfilment centre or authorised service centre for help, quoting the model, the serial number, the software version (where appropriate) and giving a detailed description of the fault. Your contact will advise you fully on actions that need to be taken. When returning a unit, the original packaging should be used to avoid transit damage. Replacement packaging sets may be purchased from dCS.











## Operating conditions

- The supply voltage must remain within +/-10% of the A.C. voltage specified on the back panel.
- The supply frequency must be in the range 49 Hz to 62 Hz.
- Ambient temperature range: 0°C (32°F) to 45°C (113°F), non-condensing.
- Do not install the unit near heat sources such as radiators, air ducts, power amplifiers or direct strong sunlight.

# Compliance

## Product label

The product label on the bottom of the unit provides information about the unit, including the serial number. It also displays safety, compliance and regulatory markings.

Marking	Description
	Intended to alert the user to the presence of uninsulated dangerous voltages within the product's enclosure, which may be sufficient in magnitude to constitute a risk of electrical shock to the user.
	Caution: To prevent electrical shock, do not remove covers. No user serviceable parts inside. Refer any servicing to a qualified technician.
	This product is not suitable for operation at altitudes above 2000m.
	The user instructions contain important cautionary information (warnings/precautions) and must be read before using the product. Keep the user instructions in a safe place.
	This product conforms with the requirements set out in the European CE directives when installed and used in accordance with this manual. For continued compliance, servicing must be referred to a qualified service technician.
	The product is compliant with UK standards.
	The crossed out wheellie bin (WEEE symbol) is the European symbol for indicating that this equipment must not be disposed of in general rubbish. You are liable to dispose of all your electronic or electrical waste by relocating to the specified collection point for recycling of hazardous waste. Collection, proper recovery and recycling of electronic waste equipment at the end of the product life cycle will allow us to help preserve the environment. Please return the unit or contact your fulfilment centre for more information.
	The product is compliant with EU2015/863 on restricted substances.
	This equipment has been tested and found to comply with the limits for a Class B digital device, pursuant to Part 15 of the FCC Rules. ▶ For more information, see "FCC compliance statement" on the next page.
	This product is in compliance with the China Compulsory safety scheme as administered by CNCA and meets safety and EMC requirements.
	This product is in compliance with Korean product safety and has been awarded the Korean certificate (KC) mark.

## FCC compliance statement



This equipment has been tested and found to comply with the limits for a Class B digital device, pursuant to part 15 of the FCC Rules.

These limits are designed to provide reasonable protection against harmful interference in a residential installation. This equipment generates, uses and can radiate radio frequency energy and, if not installed and used in accordance with the instructions, may cause harmful interference to radio communications. However, there is no guarantee that interference will not occur in a particular installation.

You can determine whether this equipment is causing interference by turning it off. If the interference stops, it was probably caused by the equipment or a peripheral device.

If your equipment does cause interference to radio or television reception, try to correct the interference by one or more of the following measures:

- Turn the television or radio antenna until the interference stops.
- Move the equipment to one side or the other of the television or radio.
- Move the equipment further way from the television or radio.
- Plug the equipment into an outlet that is on a different circuit from the television or radio. (That is, make certain the equipment and the television or radio are on circuits controlled by different circuit breakers or fuses.)

(USA only) If necessary, consult dCS Americas LLC or an experienced radio / television technician for additional suggestions.

Changes or modifications not expressly approved by dCS Americas LLC could void the manufacturer's warranty.

This product has demonstrated electromagnetic interference compliance under conditions that included the use of compliant peripheral devices and shielded cables between system components. In order to maintain compliance with FCC regulations, shielded cables (including Ethernet network cables) must be used with this equipment. Operation with non-approved equipment or unshielded cables is likely to result in interference to radio and TV reception.

Responsible party (contact for FCC matters only)

dCS Americas LLC,  
PNC Bank Bldg,  
300 Delaware Ave, Suite 210,  
Wilmington, DE 19801,  
USA

## EU Declaration of Conformity

This equipment has been tested and found to comply with the essential requirements of the following Directives: 2014/30/EU, 2014/35/EU and 2015/863/EU.

This device is certified for indoor use only.



## Korea Class B compliance statement

This equipment is for home use, and has acquired electromagnetic conformity registration, so it can be used not only in residential areas, but also other areas.

이 기기는 가정용(B급) 전자파적합기기로서 주로 가정에서 사용하는 것을 목적으로 하며, 모든 지역에서 사용할 수 있습니다.

This page is intentionally blank.