

Quick-Start Guide

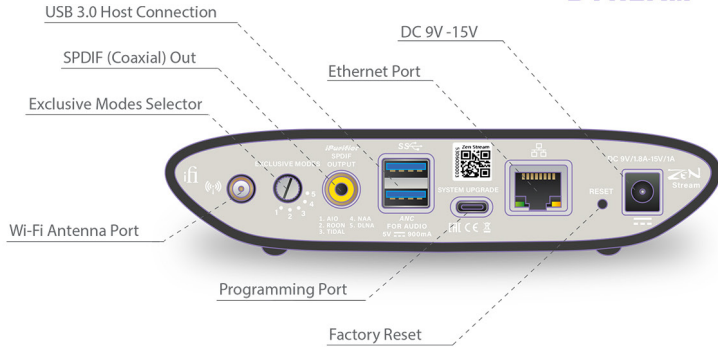

Ethernet Set-Up

- 1 Select mode 1 (AIO), Connect LAN, DAC via SPDIF/Coaxial or USB, and Power Supply.

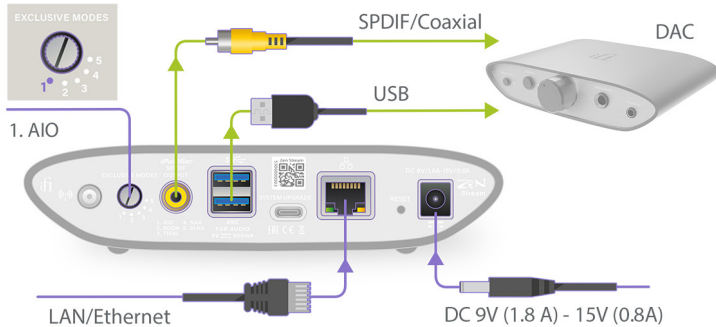

- 2 Power on.

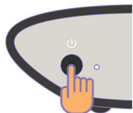

- 3 Ready to connect.

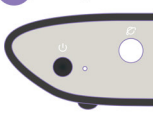

○ Fast (Internet)

● Fast (Local network only)

- 4 iOS Enter "http://ifi.local" (n/a)

- 5 Confirmation of wired connection.

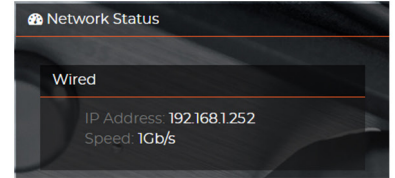

Music Streaming



Open Tidal app

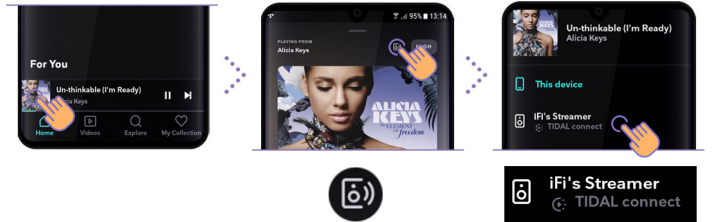

Other Compatible Apps



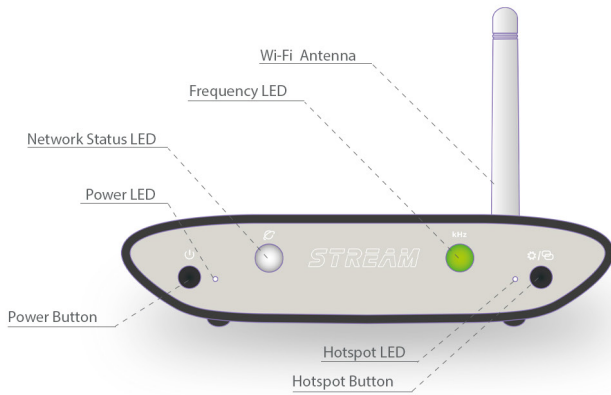

Wi-Fi Set-Up

- 1 Select mode 1 (AIO), connect Wi-Fi Antenna, DAC via SPDIF/Coaxial or USB, and Power Supply.

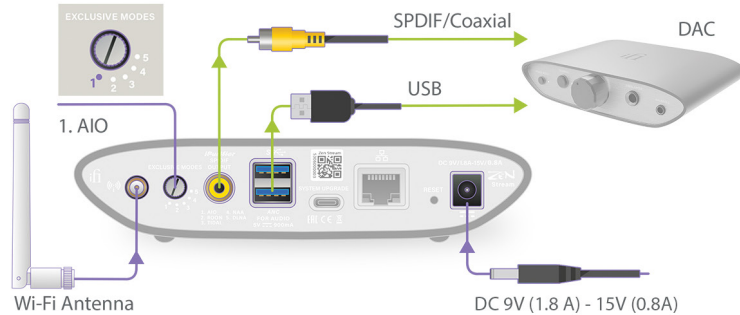

- 2 Power on.
- 3 Wait up to 2 minutes.
- 4 Press and hold Hotspot button for 2 seconds.

- 5 In your device's Wi-Fi settings, connect to 'iFi-Streamer'.

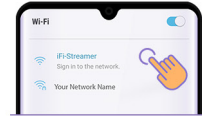

- 6 The hotspot LED will show solid white to indicate your device is connected.

- 7 Enter "http://ifi.local" or "192.168.211.1"
 Enter "192.168.211.1"

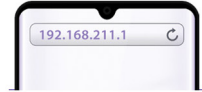

- 8 Connect the Stream to your local Wi-Fi network.

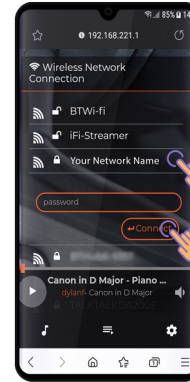

Once connected you will see a yellow box on the top right. Hotspot LED will go off.

Enter the network password and press Connect.

- 9 Network Status LED:

- 10 Connect device back to local Wi-Fi network (if not already connected).

- 11 Go to Music Streaming section.