

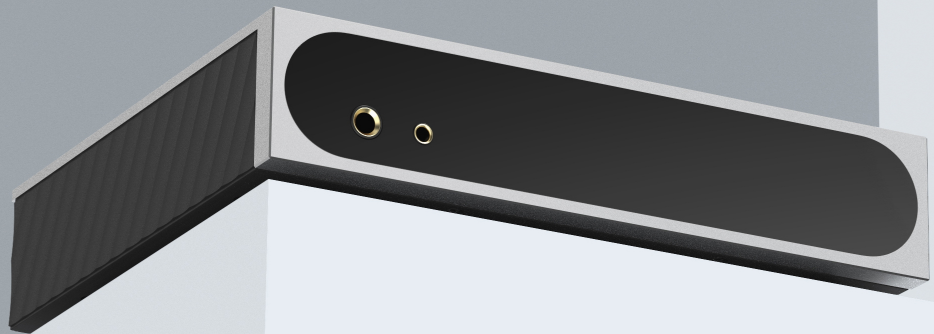

矩声®



mini-i Pro 4 | User Manual
Music Streamer

Packing list	01
Parts and names	02
Top	02
Front	02
LCD Screen	02
Rear	03
Remote control.	04
Operations before using	05
Connect to network	05
MA Remote App	05
Driver for USB Audio	06
Appendix	08
Technical specifications	08
Power specifications	09
Other specifications	09
About MQA	10
About Roon Ready	10
About Spotify	10

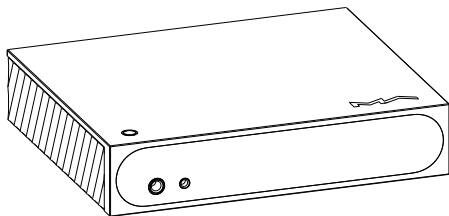

Product



Remote control

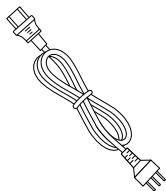

Power cable

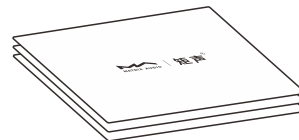

Quick start guide, warranty card

Top

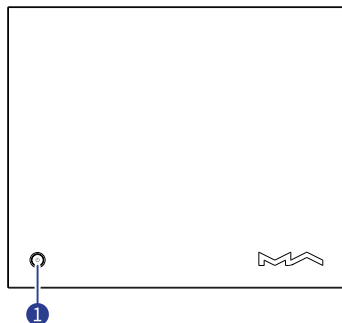

1 Power on/Standby

After connecting to the power supply, press this button to turn on the unit, hold the button for two seconds to standby. It takes about 30 seconds for the first start up after connecting to the power supply each time. When the device is working, press this button to mute, press again to unmute.

Front

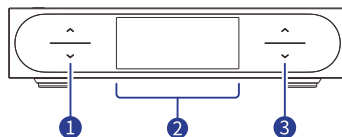

1 Headphone jack

The 6.35 mm headphone jack is for single-ended headphones, the 4.4 mm headphone jack is for balanced headphones.

2 LCD screen

3 Volume key

Tap on the arrow keys to change the volume step by step.

Hold the arrow keys for more than two seconds to change the volume rapidly.

LCD screen

Main information



1 Media and audio information

Including album art, track title, artist, duration, audio format, sampling rate of the track and the filter type being used.

2 Input channel

The name of selected input channel.

3 Status bar

Including status of clock and network connection.

4 Output channel and volume

The selected output channel and volume level.

Operation of touch screen



Swipe right to open the shortcut page.

Swipe left to open the menu.

Rear

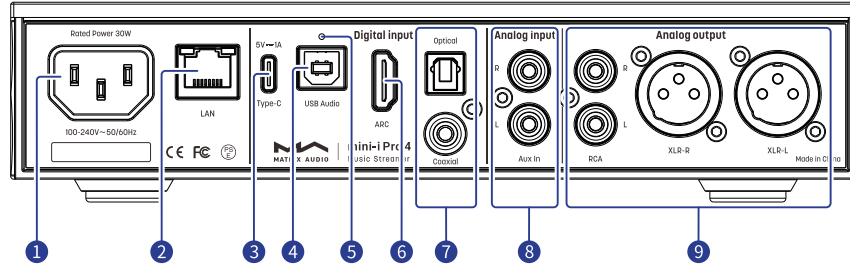
**1 AC input**

This unit adapts to AC100-240V power voltage range. Please make sure to use the product in the power voltage range mentioned above.

*Please use the power cable which includes an earth wire. Please ensure you have a reliable earth wire connection. Otherwise, the casing of the unit may have a slightly charged touch. If you need the unit to be turned off completely, please unplug the power cable.

2 Ethernet

Connect to LAN port of the network router, the connection supports up to Gigabit Ethernet transmission.

3 USB Type C

Connect to USB storage devices which requires not higher than 5V/1A power supply.

4 USB Audio

Connect to computers, smart phones and tablets as external audio source devices through USB-B cables.

5 Reset button

Only use this button when the device works incorrectly, the device can be reset to factory state. Please operate under the instructions by service team from Matrix Audio.

6 HDMI ARC

Connect to TVs with ARC(Audio Return Channel)functionalities through HDMI cables.

7 Optical & Coaxial input

Connect to front-end devices with S/PDIF signal outputs through optical or coaxial cables.

8 Analog input

Connect to vinyl turntables or devices with analog outputs through RCA cables.

9 Analog output

Connect to active speakers or amplifiers through RCA or XLR cables.

Remote control

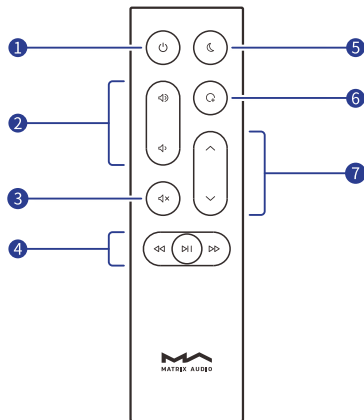
**1 Power on/Standby****2 Volume****3 Mute/Unmute**

Press to mute, press again to unmute. You also can unmute by pressing the $\llbracket \text{M} \rrbracket$ buttons in mute state.

4 Playback control area

When the input channel supports, the playback can be controlled by these buttons.

5 Dimmer**6 Programmable button**

Define the functionalities of the programmable button through MA Remote App, the function is set to 'Filter' by default.

7 Input channels

The remote control uses a CR2032 battery. Slide the battery cover in the direction of the arrow to open the battery holder. Please pay attention to the polarities when installing the battery.

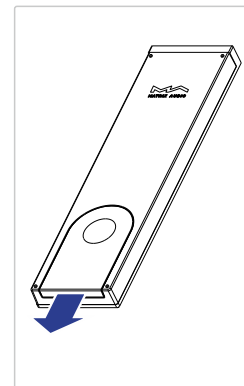
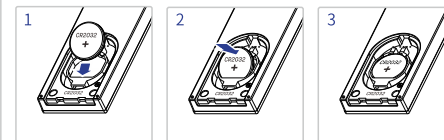
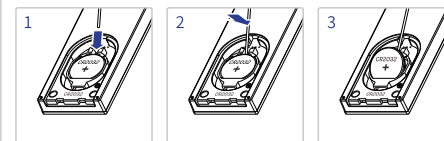
**Install a CR2032 battery****Remove the battery**

Point the remote control to the device when using it, the operating distance is about 8 meters. When the battery is low, there will be a message showing on the device display to notify you about replacing the battery.

If there are more than one Matrix Audio device in a single environment, in order to prevent 1 remote control from controlling multiple devices at the same time, we preset 5 sets of address codes in the remote control, these address codes can be configured in the Settings menu showing below, and follow the instructions on the device display.

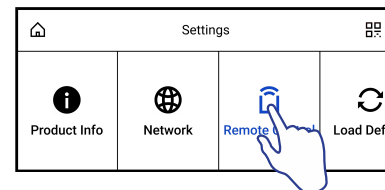

Connect to network

LAN

Connect the product to the LAN port of the network router through an Ethernet cable. It is recommended to set up the router as a DHCP server. The unit will be assigned an IP address automatically. Select "LAN" in option Network in Settings menu, after joining the network, there will be a  shown in the status bar.

Wi-Fi

Enter Settings menu - Network - Wi-Fi, after network scanning complete, choose the SSID of your network and enter the passwords, there will be a  shown in the status bar after connected. The device supports 2.4GHz/5GHz wireless network.

When the connection has no Internet access, there will be a  in the status bar.

MA Remote App

Install MA Remote App for your iPad, iPhone or Android phone.



Open the app, it will automatically search for the device and enter the home page after the device is added.

If you need to add the device manually, you can follow the prompts in the app wizard and scan the host QR code to add it manually.

* Please make sure the device and your phone or iPad in the same network before connection.



To control and configure the device through MA Remote App, or playback streaming music from the element devices, please refer to www.matrix-digi.com/tutorials for instructions.



Tutorial Video

Driver for USB Audio

When connecting the device to a Windows 7/8/10/11 computer via USB connection as an external audio device, please install drivers as following instructions:

1. Double-click the driver installation package and click "Next".

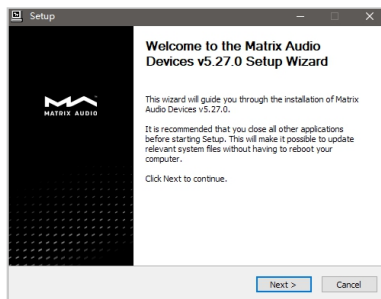

2. Select installation path and click "Install".

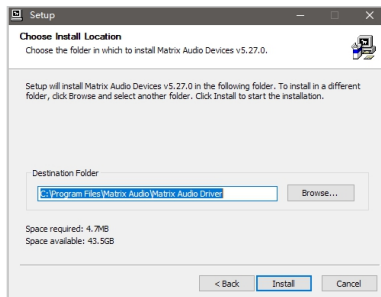

3. Click "Next" after the installation is complete.

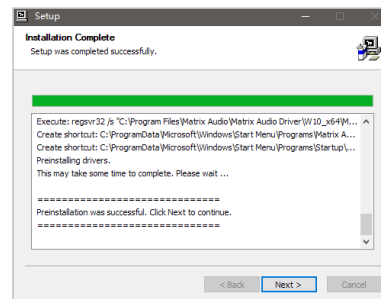

4. Click "Finish" to close the Setup Wizard.

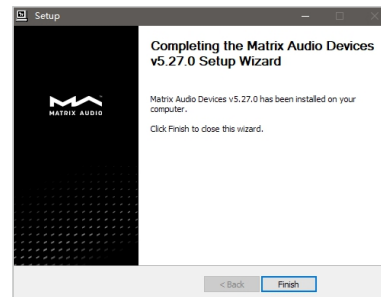

It's no need to install drivers for macOS, just select "mini-i Series" as the audio output device in Sound Preferences.

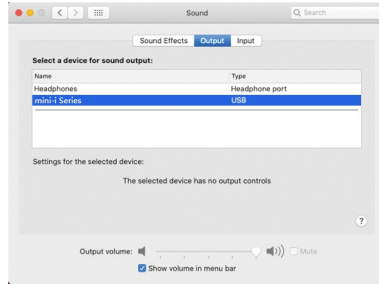

The device can be connected to an iPhone or iPad via a Lightning to USB Camera Adapter.

The device can be connected to Android devices via an OTG adapter, but not every Android devices are compatible with the device via OTG connection.

Technical specifications

Hardware Platform

CPU : Quad Cortex-A55 2.0GHz
D/A Chip : ES9039Q2M

Digital Input

COAXIAL & OPTICAL

PCM 16-24Bit/44.1kHz, 48kHz, 88.2kHz, 96kHz, 176.4kHz, 192kHz
DSD 2.8MHz (DoP)

HDMI ARC

PCM 16-24Bit/44.1kHz, 48kHz, 88.2kHz, 96kHz, 176.4kHz, 192kHz

USB Audio

PCM 16-24Bit/44.1kHz, 48kHz, 88.2kHz, 96kHz, 176.4kHz, 192kHz, 352.8kHz, 384kHz, 705.6kHz, 768kHz
MQA 16-24Bit/44.1kHz, 48kHz, 88.2kHz, 96kHz, 176.4kHz, 192kHz, 352.8kHz, 384kHz MQA or MQA Studio stream
DSD 2.8MHz, 5.6MHz, 11.2MHz (DoP)
DSD 2.8MHz, 5.6MHz, 11.2MHz, 22.4MHz (Native)

Aux Input

SNR : 100dB A-weighting
THD+N : <0.0035%@1k, <0.0035%@20Hz-20kHz
Frequency Response : 20Hz-20kHz ± 0.1 -3dB@46kHz
Channel Crosstalk : >-105dB
Input Level : 2.1VRMS Maximum

Line Output

XLR
SNR : 127dB A-weighting
THD+N : <0.00008%@1k, <0.00010%@20Hz-20kHz

Frequency Response : 20Hz-20kHz ± 0.1 -3dB@90kHz
Crosstalk : >-146dB
Output Level : 4.4VRMS@0dB

RCA

SNR : 121dB A-weighting
THD+N : <0.00015%@1k, <0.00020%@20Hz-20kHz
Frequency Response : 20Hz-20kHz ± 0.1 -3dB@90kHz
Channel Crosstalk : >-133dB
Output Level : 2.2VRMS@0dB

Headphone Output

4.4mm Balanced

SNR : 117dB A-weighting
THD+N : <0.0004%@20Hz-20kHz 4VRMS
Frequency Response : 20Hz-20kHz ± 0.1 -3dB@90kHz
Output Impedance : <22 Ω
Output Power : 2200mW@33 Ω , 950mW@300 Ω , 500mW@600 Ω , 1%THD
Gain : +14dB

6.35mm Single-ended

SNR : 116dB A-weighting
THD+N : <0.0005%@20Hz-20kHz 2VRMS
Frequency Response : 20Hz-20kHz ± 0.1 -3dB@90kHz
Output Impedance : <11 Ω
Output Power : 1200mW@33 Ω , 260mW@300 Ω , 130mW@600 Ω , 1%THD
Gain : +14dB

Network

LAN : 10/100/1000 Mbps
WLAN : 2.4 GHz / 5 GHz

USB Type C

The USB Type C port provides a maximum power of 5V/1A.

The USB Type C port works with devices which conform to the USB mass storage standard and supports FAT, FAT32, exFAT, and NTFS file formats, but is not guaranteed to be compatible with all storage devices.

MA Player

Controller app : MA Remote App

Local Playback :

Format Supported

MP3, WMA, WAV, AIF, AIFF, AAC, FLAC, OGG, APE, ALAC, M4A, DSF, DFF, CUE

PCM 16-24Bit/44.1kHz, 48kHz, 88.2kHz, 96kHz, 176.4kHz, 192kHz, 352.8kHz, 384kHz, 705.6kHz, 768kHz

MQA 16-24Bit/44.1kHz, 48kHz, 88.2kHz, 96kHz, 176.4kHz, 192kHz, 352.8kHz, 384kHz MQA or MQA Studio stream

DSD 2.8MHz, 5.6MHz, 11.2MHz, 22.4MHz

AirPlay 2, DLNA/UPnP, TIDAL Connect, Spotify Connect, vTuner, Radio Paradise, HIRESAUDIO, the audio specs depend on the service provider.

Power specifications

Power Voltage : AC 100V-240V 50/60Hz

Standby Power Consumption : < 5W

Maximum Power Consumption : < 30W

Other specifications

Weight : 1.3kg (2.87 pounds)

Size : Width 224 mm (8.80 inches)

Depth 186 mm (7.32 inches)

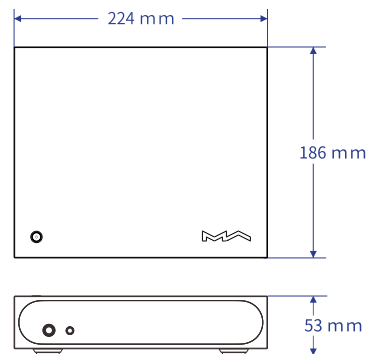

Height 53 mm (2.07 inches)



*Specifications are subject to change without notice.

About MQA (Master Quality Authenticated)

This unit includes a MQA full decoder, which enables you to playback MQA audio files via streaming or USB audio port, delivering the sound of the original master recording.

The dots beside the MQA logo green MQA or blue MQA, to indicate that the unit is decoding and playing an MQA stream or file, and denotes provenance to ensure that the sound is identical to that of the source material. It glows blue MQA to indicate it is playing an MQA Studio file, which has either been approved in the studio by the artist/producer or has been verified by the copyright owner.

The dot glows magenta MQA to indicate that the unit is rendering an MQA stream or file. This delivers the final unfold of the MQA file.

*MQA and the Sound Wave Device are registered trade marks of MQA Limited. ©2016

About Spotify

Use your phone, tablet or computer as a remote control for Spotify. Go to www.spotify.com/connect to learn how.

The Spotify Software is subject to third party licenses found here:

<https://www.spotify.com/connect/third-party-licenses>

- This product is for indoor use only.
- For full ventilation, it is recommended to reserve a space of larger than 5 cm around the device.
- Do not cover the air vents with stuffs such as papers, tablecloths, and curtains to obstruct ventilation.
- Do not place stuff with flame, such as lighted candles, on the device.
- If the device is used in tropical areas, please be careful to prevent insects from entering the unit through the air vents.
- The device must not be subject to water droplets or splashes. Please do not place stuffs filled with liquids such as vases and cups on or near the device.
- Do not put stuffs around the device power plug and the AC power socket, in order to disconnect the power supply easily when needed.

Into The Music

www.matrix-digi.com

Matrix Electronic Technology Co., LTD
+86-29-86211122
B-801, No.111 Fengcheng 5th Rd.,
Xi'an, China

