



## AMBEO Soundbar System SB02

Multi-speaker home cinema system

- AMBEO Soundbar | Plus  
Model: SB02M
- AMBEO Sub  
Model: SW02



**Instruction manual**

**i** This instruction manual contains all information on the current firmware version. Firmware updates can be downloaded free of charge from the Internet (> 69).

Use the search function, the navigation (left) or the following links:

Start

“Product overview”

“Getting started”

“Setting up the Soundbar and a Sub”

“Connecting devices to the Soundbar”

“Putting the Soundbar into operation”

“Operating the Soundbar”

“Using the Soundbar”

“Care and maintenance of the Soundbar”

“Specifications”

**Sonova Consumer Hearing GmbH**

Am Labor 1  
30900 Wedemark  
Germany

[www.sennheiser-hearing.com](http://www.sennheiser-hearing.com)

Version: 09/22 A02

## Important safety instructions



1. Read these safety instructions and the instruction manual of the product.
2. Keep these safety instructions and the instruction manual of the product. Always include the safety instructions and the instruction manual when passing the product on to other users.
3. Heed all warnings.
4. Follow all instructions.
5. Do not use the product near water.
6. Only clean the product when it is not connected to the power supply system. Clean only with a dry cloth.
7. Ensure circulating ventilation. The product generates heat which is dissipated through the housing. Install in accordance with the manufacturer's instructions.
8. Do not install near any heat sources such as radiators, stoves, or other products that produce heat and do not expose to direct sunlight.
9. Do not defeat the safety purpose of the polarized or grounding-type plug. A polarized plug has two blades with one wider than the other. A grounding type plug has two blades and a third grounding prong. The wide blade or the third prong are provided for your safety. If the provided plug does not fit into your outlet, consult an electrician for replacement of the obsolete outlet.
10. Protect the power supply cord from being walked on or pinched, particularly at plugs, convenience receptacles, and the point where it exits from the product.
11. Use only attachments/accessories/spare parts supplied or recommended by Sonova Consumer Hearing.
12. Use only with shelves, racks, or tables that can safely support the weight of the product (see instruction manual).
13. Unplug the product during lightning storms or when unused for long periods of time.
14. Refer all servicing to qualified service personnel. Servicing is required when the product has been damaged in any way, such as power supply cord or plug is damaged, liquid has been spilled or objects have fallen into the product, when the product has been exposed to rain or moisture, does not operate normally, or has been dropped.
15. **WARNING:** To reduce the risk of fire and electric shock, do not expose the product to dripping or splashing and ensure that no objects filled with liquids, such as vases, are placed on the product.
16. To completely disconnect this product from the AC mains, disconnect the power supply cord plug from the AC receptacle.
17. The plug of the power supply cord and the AC receptacle shall remain readily accessible.
18. Use the product only at altitudes up to 6562 ft/2000 m above mean sea level.

### Hazard warnings on the bottom of the product

The following label is attached to the bottom of the product.



The symbols on this label have the following meaning:



Read and follow the safety and operating instructions contained in this instruction manual.





Presence of uninsulated dangerous voltage within the product's enclosure that may be of sufficient magnitude to constitute a risk of fire or electric shock.

CAUTION / AVIS / 小心  
Risk of electric shock, do not open  
Risque de choc électrique, ne pas ouvrir  
有电击风险 请勿打开

Never open the product. There is a risk of electric shock when touching live parts. There are no user serviceable parts inside the product. Refer repairs to an authorized Sonova Consumer Hearing partner.

### Preventing damage to health and accidents

- ▷ Protect your hearing from high volume levels. Do not listen at high volume levels for long periods of time to prevent hearing damage. 
- ▷ The product generates stronger permanent magnetic fields that could cause interference with cardiac pacemakers, implanted defibrillators (ICDs) and other implants. Always maintain a distance of at least 3.94"/10 cm between the product component containing the magnet and the cardiac pacemaker, implanted defibrillator, or other implant. 
- ▷ Keep the product, accessories and packaging parts out of reach of children and pets to prevent accidents. Swallowing and choking hazard.
- ▷ Do not use the product in an environment that requires your special attention (e.g. when performing skilled jobs).
- ▷ The product generates heat which is dissipated through the housing. Avoid prolonged skin contact with the product during use and immediately afterwards to prevent skin irritation. 

### Preventing damage to the product and malfunctions

- ▷ If the product was moved from a cold environment to a warm one, allow the product to stand for at least 2 hours before putting it into operation.

Safety instructions for Lithium coin batteries (marking with CR or Li)

The coin battery is for use with the SB02-RC remote control.



**WARNING**

If abused or misused, batteries may leak. In extreme cases, they may even present a risk of:

- explosion
- heat and fire development
- smoke and/or gas development
- damage to health and/or the environment

	If you think batteries have been swallowed or are lodged in the body, seek medical assistance immediately.
	Keep away from children.
	Observe correct polarity.
	Immediately remove the batteries from obviously defective product.
	Do not expose to moisture.
	Do not mutilate or dismantle.
	Remove the batteries if the product will not be used for extended periods of time.
	Pack/store batteries so that the terminals cannot contact each other – danger of shorting out/fire hazard.
	Only use batteries specified by Sonova Consumer Hearing.
	Store the product in a cool and dry place (approx. 20 °C/ 68 °F).
	Do not continue to use defective batteries.
	Do not heat above 70 °C/158 °F, e.g. do not expose to sunlight or throw into a fire.
	Dispose of exhausted batteries at special collection points or return them to your specialist dealer to facilitate recycling. To avoid short circuits, cover the poles of the batteries with tape.



For AUSTRALIA: If you suspect your child has swallowed or inserted a coin battery, call the Poisons Information Centre immediately on 131126 for 24/7 fast, expert advice. If your child is having any difficulty breathing, call 000.

### Notes on data collection and processing and on firmware updates

This product stores individual settings such as volume, sound and UI settings (e.g. LED brightness), selected input and designations, Bluetooth addresses of paired devices, WiFi settings and usage data (e.g. power-on cycles and operating times). This data is required for the operation of the product and is not transferred to Sonova Consumer Hearing GmbH or companies commissioned by Sonova Consumer Hearing GmbH and is not processed.

You can update the firmware of the product for free via an Internet connection. If the product is connected to the Internet, the following data is automatically transferred to and processed by Sonova Consumer Hearing servers in order to provide and transfer suitable firmware updates: MAC address, IP address. The data will only be used as specified and will not be stored permanently. If you do not want this data to be transferred and processed, do not connect to the Internet.

### Intended use/Liability

This product has been designed for playing TV sound and music via cable connections, Bluetooth, WiFi or Ethernet. This product is intended for private domestic use only. It is not intended for commercial use.

It is considered improper use when this product is used for any application not named in the instruction manual. Sonova Consumer Hearing GmbH is not liable for damages to devices that are not consistent with the interface specifications (USB, HDMI, Ethernet). Sonova Consumer Hearing GmbH does not accept liability for damage arising from misuse or improper use of this product and its attachments/accessories.

Before putting the product into operation, please observe the respective country-specific regulations.

### Notes on the packaging

We recommend using the original packaging to ensure safe storage and transport of the products. Damage during transport is often caused by the use of unsuitable packaging. The original packaging of the products provides optimal protection and minimizes the risk of damage during transport.

## Presentation conventions

In this manual, the labels of the product’s controls and connectors are highlighted in blue.

Example:

OPTICAL IN input

The original English texts of the user interface of the Sennheiser Smart Control app such as names of menus and buttons are highlighted in blue.

Example:

Calibrate now button

▷ A triangle indicates a request for action.

- A period indicates bulleted lists.

1. Ordinal numbers simplify orientation in complex action sequences and enumerations.

## Presentation of warnings

In this manual, warnings are placed at the beginning of sections when hazards may occur during the situations described in the sections.

Warnings are structured as follows:



---

### SIGNAL WORD

**Type and source of danger!**

Consequences if the warning is not observed.

▷ Measures to avoid danger

---



The warning sign indicates dangers to life and injury to persons. Warnings without a warning sign warn of damage to property.

The signal word indicates the severity of the danger:

Signal word	Meaning
Warning	The signal word Warning warns of possible hazards that can lead to death or serious injury.
Caution	The signal word Caution warns of possible hazards that can lead to injuries.
Attention	The signal word Attention warns of situations that can lead to property damage.

The information on the type and source of the hazard describes the type of hazard and what causes the hazard.

The information on consequences of non-observance describes what will happen if the warning is not observed and the hazard is not avoided.

The information on measures to avoid the hazard describes how you can avoid the hazard.

## Package contents

### AMBEO Soundbar | Plus



AMBEO Soundbar | Plus  
Model: SB02M

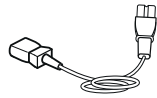

Power cable, country-specific, length approx. 1 m

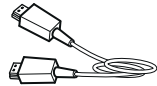

Premium High-Speed HDMI® Cable, length approx. 1 m



Remote control, model: SB02-RC  
(incl. 1x CR2032 battery)



Quick guide



Safety guide

### AMBEO Sub



AMBEO Sub  
Model: SW02

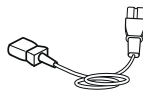

Power cable, country-specific, length approx. 1 m



Quick guide



Safety guide

## SB02-WM wall mount

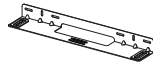

Wall mount for Soundbar | Plus



2 screws (M4x15) for wall mounting the Soundbar



Allen key (HX 3)



Mounting instructions

Online you can find:

- this detailed instruction manual and additional information ([www.sennheiser-hearing.com/download](http://www.sennheiser-hearing.com/download))
- the Sennheiser Smart Control app for configuring the AMBEO Soundbar SB02 and for additional functions ([www.sennheiser-hearing.com/smartcontrol](http://www.sennheiser-hearing.com/smartcontrol))
- a list of accessories on the AMBEO Soundbar SB02 product page at [www.sennheiser-hearing.com/ambeo-soundbar-plus/](http://www.sennheiser-hearing.com/ambeo-soundbar-plus/) or [www.sennheiser-hearing.com/ambeo-sub/](http://www.sennheiser-hearing.com/ambeo-sub/) (to purchase online or contact your local Sonova Consumer Hearing partner: [www.sennheiser-hearing.com/service-support](http://www.sennheiser-hearing.com/service-support))

# Product overview

## AMBEO Soundbar | Plus

Model: SB02M

### Front

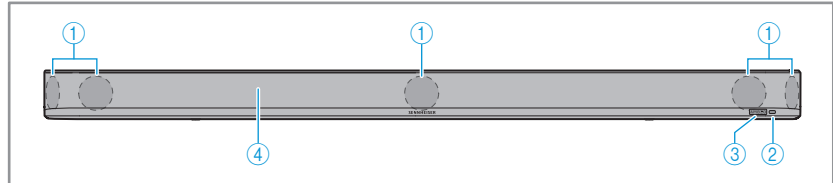

- ① Full-range speakers
- ② Infra-red receiver for SB02-RC remote control
- ③ AMBEO display
- ④ Cover (not removable)

### Top

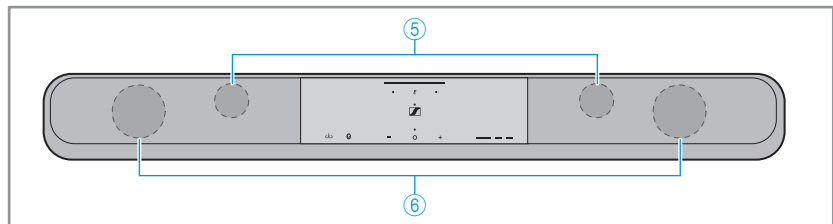

- ⑤ Top-firing full-range speakers
- ⑥ Woofer

### Control panel

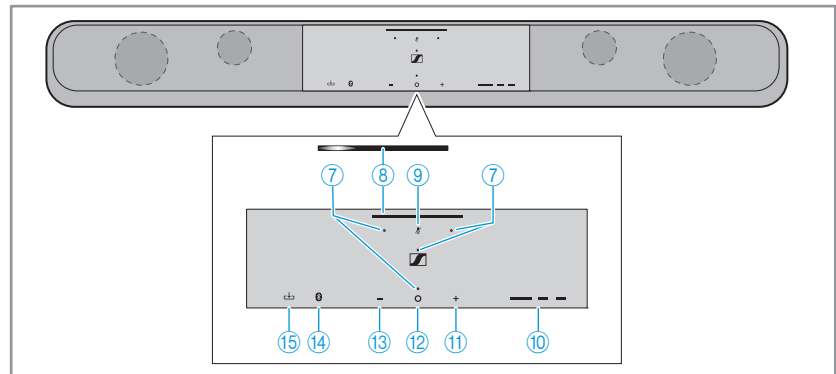

- ⑦ Microphones for room calibration and voice assistants
- ⑧ LED status bar
- ⑨ **Mic Mute** button with LED for microphone and WiFi status
- ⑩ Active Codec display
- ⑪ Volume + button
- ⑫ Multi-purpose **o** button for playback control and ECO mode or Action button for Amazon Alexa (if Alexa is activated)
- ⑬ Volume - button
- ⑭ **Bluetooth** button (press for 3 seconds to activate Bluetooth pairing)
- ⑮ **Source** button (input selection) to select connected and active devices

### Bottom

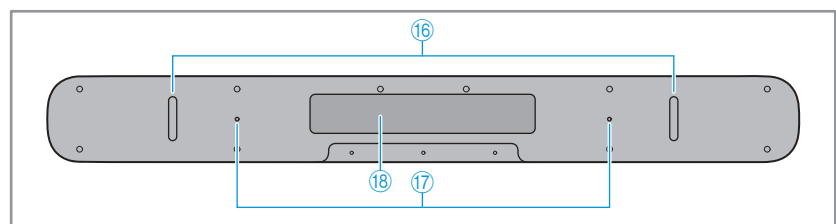

- ⑯ Vibration absorbing feet
- ⑰ Mounting thread for SB02-WM wall mount (optional accessory)
- ⑱ Type plate

## Inputs

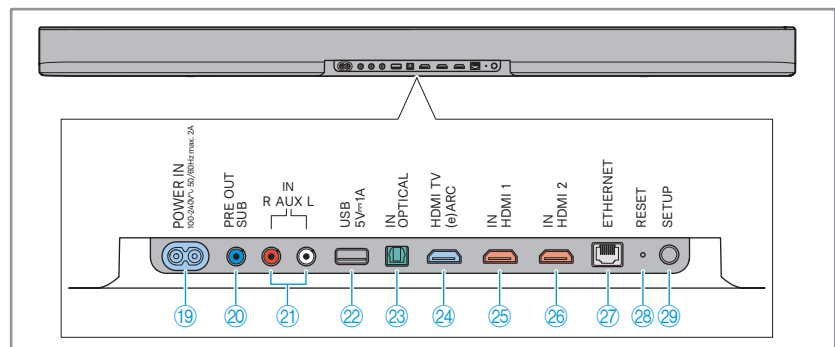









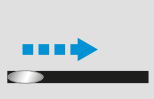





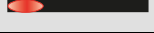

- ①9 **POWER IN** socket  
100-240 V~, 50/60 Hz, max. 2.5 A
- ②0 **PRE OUT SUB** output  
RCA socket for connecting a subwoofer with power amplifier
- ②1 **AUX IN L** and **AUX IN R** inputs  
RCA sockets for an analog audio source
- ②2 **USB** socket  
type A, 5 V, = 1 A
- ②3 **OPTICAL IN** input  
for S/PDIF, optical
- ②4 **HDMI TV (e)ARC** socket  
for HDMI
- ②5 **HDMI 1 IN** input  
for HDMI
- ②6 **HDMI 2 IN** input  
for HDMI
- ②7 **ETHERNET** socket  
for Ethernet, RJ45
- ②8 Reset button
- ②9 Setup button  
for WiFi setting (press for 3 seconds to start WiFi Protected Setup; WPS) and for connecting AMBEO Subs (press 1x).

## Overview of the Soundbar displays





**i** The brightness of the displays can be adjusted via the Sennheiser Smart Control app (> 54).

### LED status bar

LED status bar		Meaning
	white sequence from left and right	System boots
	white in steps from left	Change of input If the LED status bar lights up red when the input is changed, no other active input is available.
	blue right	Bluetooth input
	blue sequence	Bluetooth pairing mode
	white right	Network streaming input
	green right	Network streaming "Spotify" input
	purple right	Network streaming "Tidal" input
	white lighting up	Playback start/stop
	white swiping to the right	Playback of next title
	white swiping to the left	Playback of previous title
	white ascending or descending	Increase or decrease of volume
	red left	Minimum volume/volume muted
	purple sequence	Night mode "Night" activated/deactivated
	light blue sequence	Voice mode "Voice" activated/deactivated
	yellow sequence	AMBEO Sub is being connected
	white sequence	Room calibration is being performed
	white sequence	Firmware update is being installed
	red-white sequence	Reset to the factory default settings









### Mic LED





Mic LED		Meaning
	lights up red	Microphones are switched off
 or 	flashes light blue or white (for max. 2 minutes)	Soundbar has not found WiFi settings/cannot connect to WiFi WiFi hotspot ( <a href="http://192.168.255.249/">http://192.168.255.249/</a> ) is available
	flashes purple 3x	Room calibration via the Volume + and Volume - buttons on the Soundbar is not possible because the microphone is switched off (press the <b>Mic Mute</b> button on the Soundbar to deactivate the mute function)

### Active Codec LED

Only active if the input source (device, streaming contents, and the input used by the Soundbar) supports one of the codecs.

Active Codec LED		Meaning
	lights up white	DOLBY ATMOS active
	off	DOLBY ATMOS not active
	lights up white	DTS:X active
	off	DTS:X not active
	lights up white	MPEG-H active
	off	MPEG-H not active

### LED AMBEO

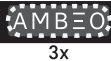
LED AMBEO		Meaning
	lights up white	AMBEO active
	off	AMBEO not active
	flashes white 1x	AMBEO "Light" activated
	flashes white 2x	AMBEO "Standard" activated
	flashes white 3x	AMBEO "Boost" activated

## AMBEO Sub subwoofer



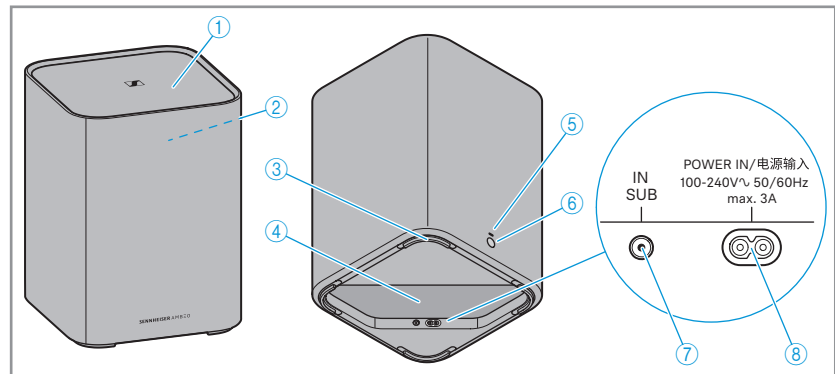





Model: SW02



- ① Cover (not removable)
- ② Woofer (not visible, radiation direction upwards)
- ③ Vibration absorbing feet
- ④ Type plate
- ⑤ Status LED
- ⑥ Setup button
- ⑦ **IN SUB** input  
RCA socket for analog subwoofer signal (only required if no wireless connection to the Soundbar is possible)
- ⑧ **POWER IN** socket  
100 – 240 V~, 50/60 Hz, max. 3 A

## Overview of the subwoofer displays

### Status LED

Status LED		Meaning
	lights up white	Sub switched on, is booting or wirelessly connected to the Soundbar
	Off	Standby/no power connection
	pulses yellow	Initial pairing mode, Sub searches for the Soundbar in pairing mode
	pulses white	Connection mode, Sub searches for the paired Soundbar
	lights up green	Sub switched on, connected to the Soundbar via RCA cable, wireless connection deactivated
	pulses blue	Room calibration active
 3x	flashes blue 3x	Room calibration successful
 3x	flashes orange 3x	All connection settings deleted

## Wall mount

Model: SB02-WM

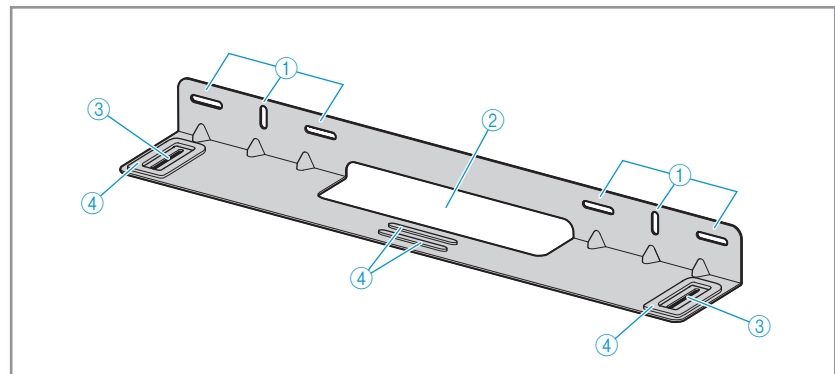

- ① Recesses for mounting (screws) to the wall
- ② Recess for cables
- ③ Recesses for mounting the Soundbar with M4x15 screws
- ④ Damping elements

## Remote control

Model: SB02-RC

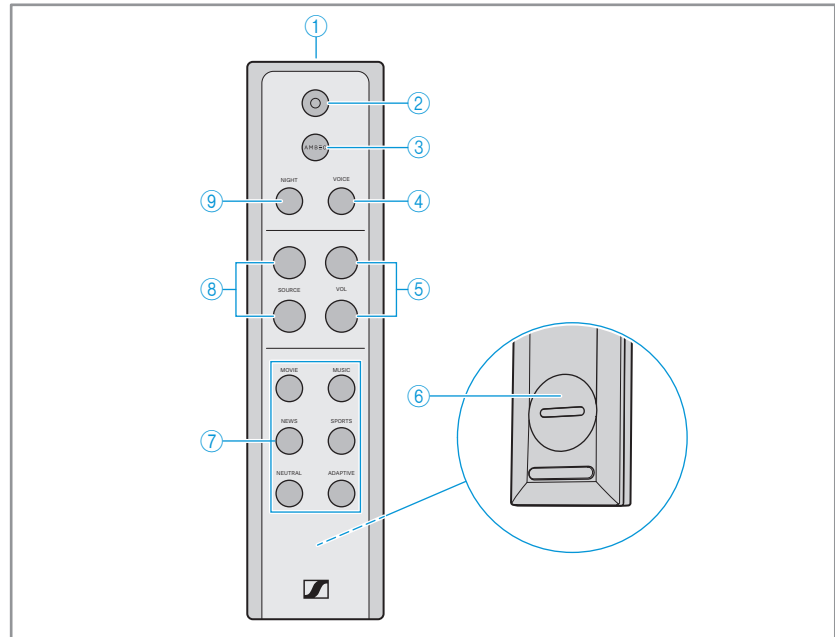

- ① Infra-red transmitting diode
- ② Multi-purpose  button for playback control and to activate the ECO mode or Action button for Amazon Alexa (if Alexa is activated)
- ③ AMBEO button for activating AMBEO
- ④ **Voice** button (voice mode)
- ⑤ Volume +/- button
- ⑥ Battery compartment (for 1x CR2032 battery)
- ⑦ Sound profile buttons **Movie**, **Music**, **News**, **Sports**, **Neutral**, **Adaptive**
- ⑧ **Source** button (input selection)
- ⑨ **Night** button (night mode)

# Getting started

## 1. Setting up the Soundbar

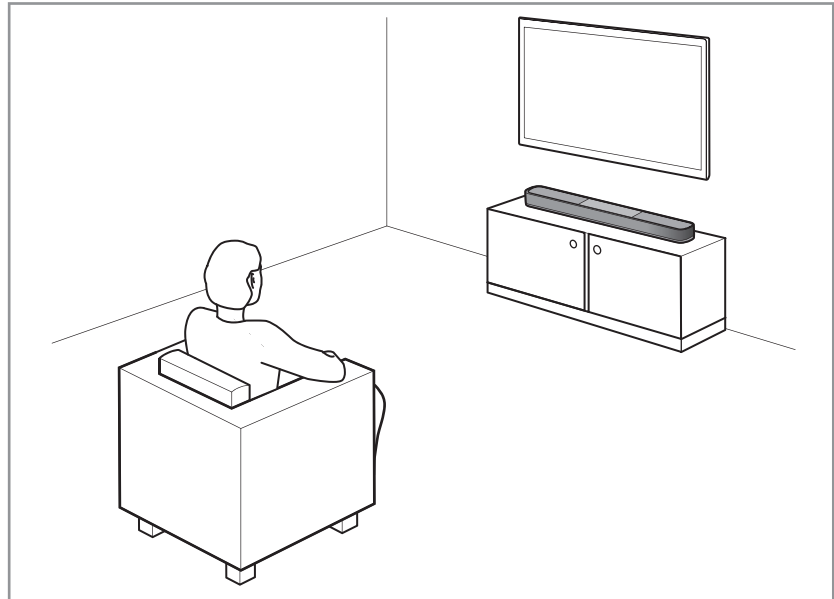

The correct placement and setup of the AMBEO Soundbar is important for an optimum sound experience. You can place the AMBEO Soundbar on a piece of furniture (> 21) or mount it directly to a wall using the wall mount (optional accessory) (> 24).

## 2. Connecting a TV and/or audio devices

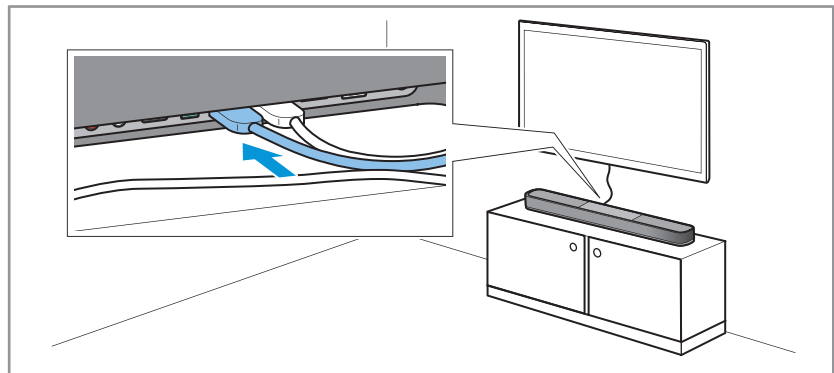

Connect your TV to the Soundbar. You can also connect other audio/video devices (> 32) or play wireless audio via Bluetooth or WiFi/Ethernet (> 51).

### 3. Connecting to the power supply system

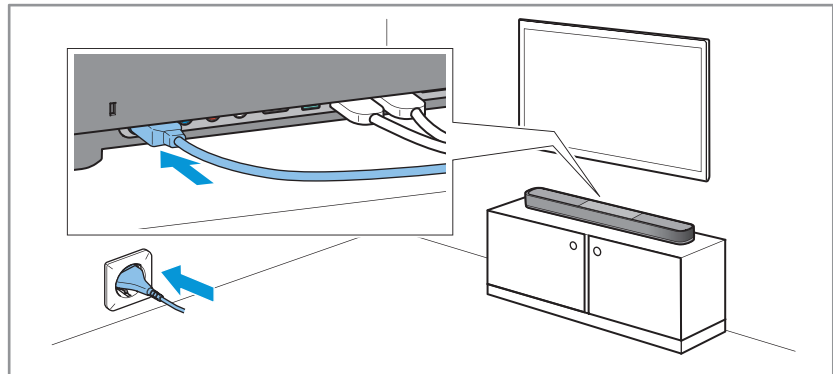

Connect the AMBEO Soundbar to the power supply system – the AMBEO Soundbar comes to life and guides you through the initial switch-on process via the Sennheiser Smart Control app (> 17).

### 4. Setting up an optional AMBEO Sub and connecting to the power supply system

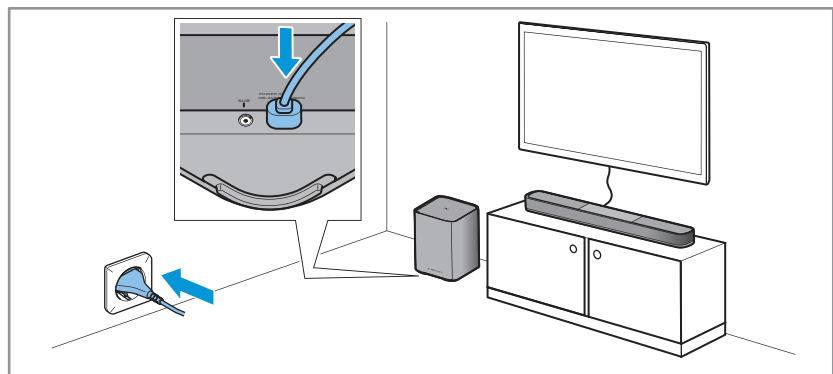

You can optionally extend the bass performance of the AMBEO Soundbar with up to 4 wirelessly connected AMBEO Subs. Place the subwoofer(s) in the same room as the Soundbar (> 21) and connect the AMBEO Sub(s) to the power supply system (> 35).

## 5. Installing the Sennheiser Smart Control app on your smartphone and establishing a WiFi connection

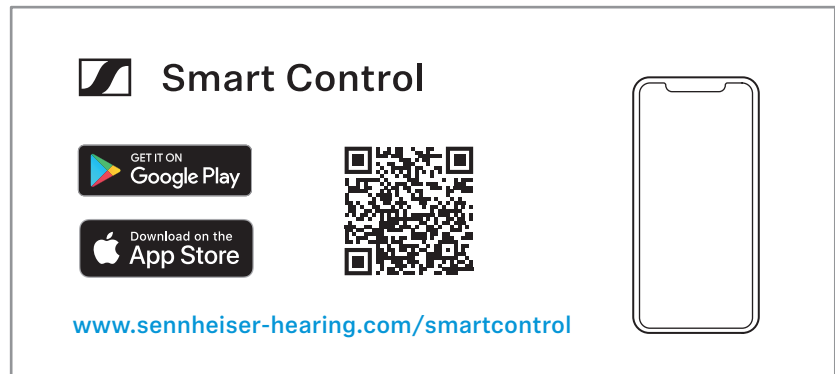

The Sennheiser Smart Control app allows you to use all the functions and settings of the AMBEO Soundbar and further guides you through setup process such as WiFi, name of the Soundbar, connection of the AMBEO Subs (optional) and room calibration.

## 6. Starting the room calibration

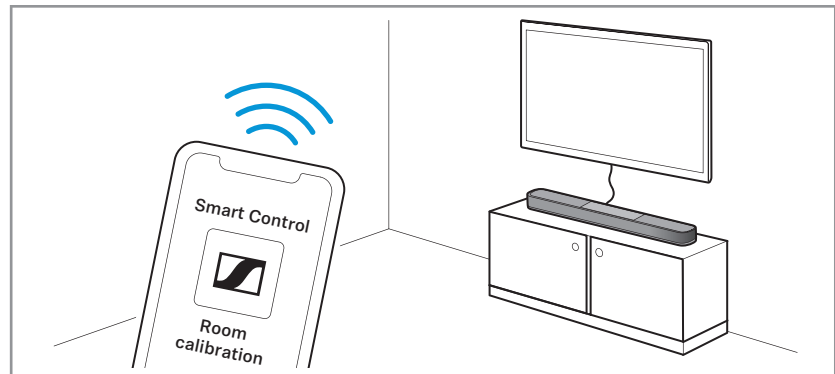

For an optimum spatial sound experience, the AMBEO Soundbar together with the optional AMBEO Subs must perform a room calibration. The calibration takes only a few minutes and leads to the best possible 3D spatial sound (> 41).

## Configuring an optional assistant such as Amazon Alexa or Ok Google

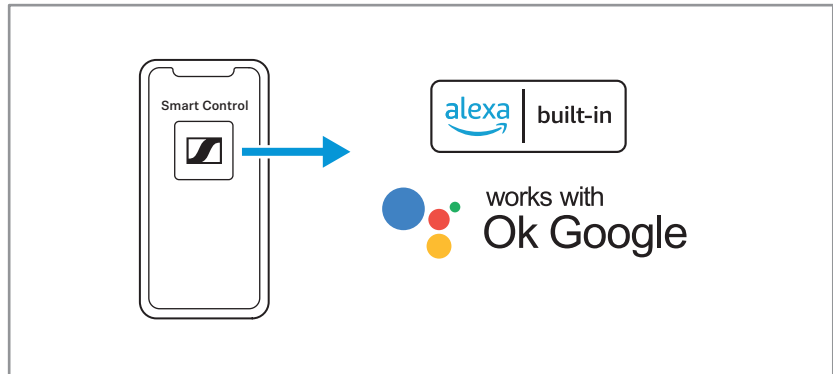

You can optionally configure the Soundbar to use the Amazon Alexa or Ok Google voice assistants. The Smart Control app will guide you through the setup process (Internet connection and user account required, availability of Amazon Alexa, Alexa Cast and Ok Google and Chromecast is region-dependent).



# Setting up the Soundbar and a Sub

## Placing the Soundbar on the device feet and positioning it

---

### ATTENTION

#### Material damage due to overheating

Inadequate ventilation may cause the Soundbar to overheat.

- ▷ Do not place any objects on the Soundbar, keep the minimum clearances and ensure circulating ventilation.

---

### ATTENTION

#### Risk of staining of furniture surfaces!

Varnish or furniture polish may degrade the feet of the product, which could stain your furniture.

- ▷ Do not place the product on delicate surfaces; if necessary, use a non-slip pad under the product.

- 
- ▷ Place the Soundbar on a sturdy, level, horizontal piece of furniture that can safely carry the weight of the Soundbar.

- ▷ Observe the following:

- The distance **X** of the Soundbar to the side walls should ideally be the same so that the Soundbar is centered in the room. The optimum distance between the Soundbar and the walls is between 1 and 5 meters.
- The Soundbar should be placed in an elevated position, at least 27.55"/70 cm high (e.g. on a piece of furniture).
- There must be no objects between the Soundbar, the side walls and the ceiling of the room that block sound or have a strong sound-absorbing effect (e.g. furniture such as shelves or arm-chairs, room dividers, curtains, flower pots).
- The distance **Y** of the Soundbar to the ceiling should be between 1 and 5 meters, but should not exceed 5 meters. The ceiling should be flat and horizontal (no pitched roof or domed roof).
- The Soundbar should be positioned centrally below the TV.
- You can optionally connect the Soundbar to 1 to 4 AMBEO Subs to give the spatial sound more volume and presence. For the positioning of the AMBEO Sub, see > 25.

## Setting up the Soundbar and a Sub

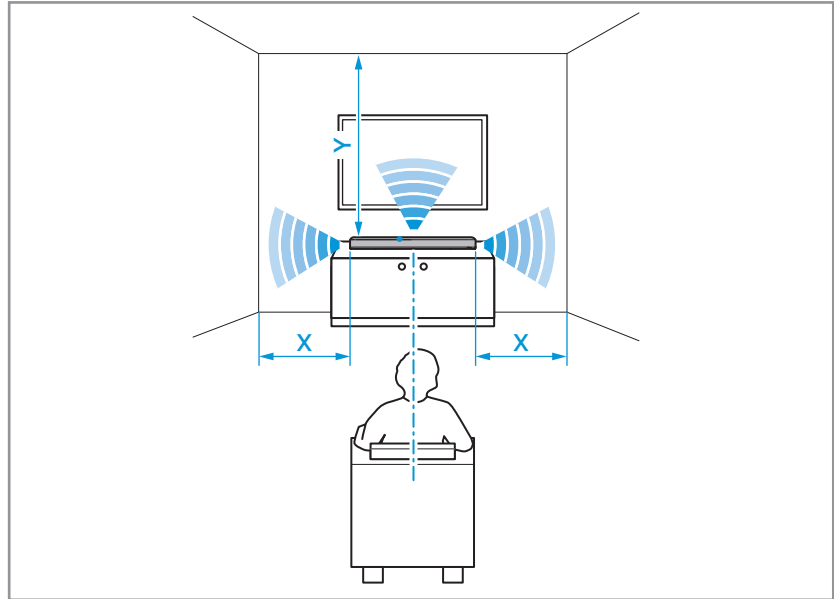

- The distance of the Soundbar to the TV should be at least 3.94"/10 cm.
- Note that with some TVs, the sensor of the remote control may be covered by the Soundbar and the remote control will no longer work. In this case, increase the distance between the Soundbar and the TV or use a commercially available IR repeater.
- The seat (optimal point "sweet spot") should be positioned centrally in front of the Soundbar and have a distance of at least 2 meters to the Soundbar.

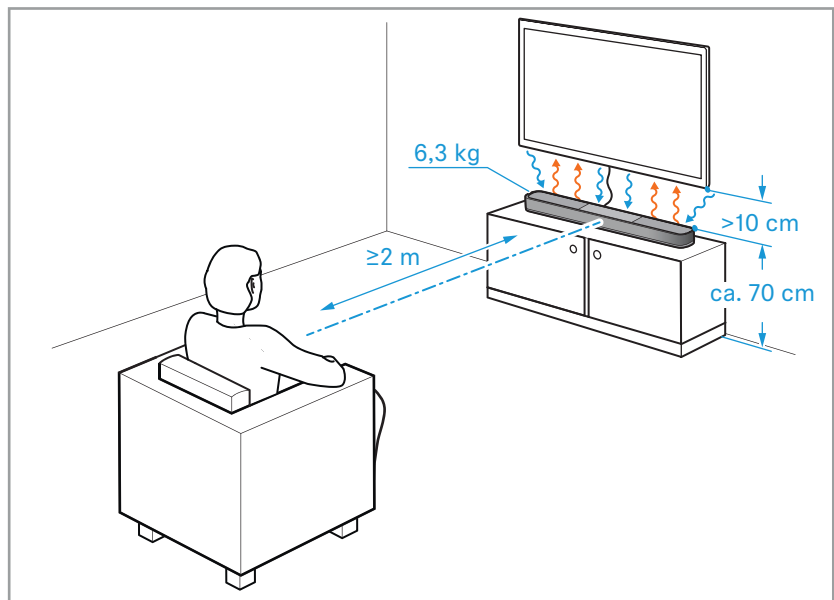

- ▷ Ensure circulating ventilation. The product generates heat which is dissipated through the housing.

### Optimum positioning

The following illustration shows the schematic structure of the sound waves starting from the Soundbar, which are reflected by walls and objects and thus reach the optimal point (“sweet spot”). Thus, virtual spatial sound can be created with a Soundbar.

Theoretically, the AMBEO Sub can be placed anywhere in the room, since the low bass sound waves cannot be located by hearing. If you are using multiple subwoofers (up to 4 are possible), note that the subwoofers have to be placed on one side/wall.

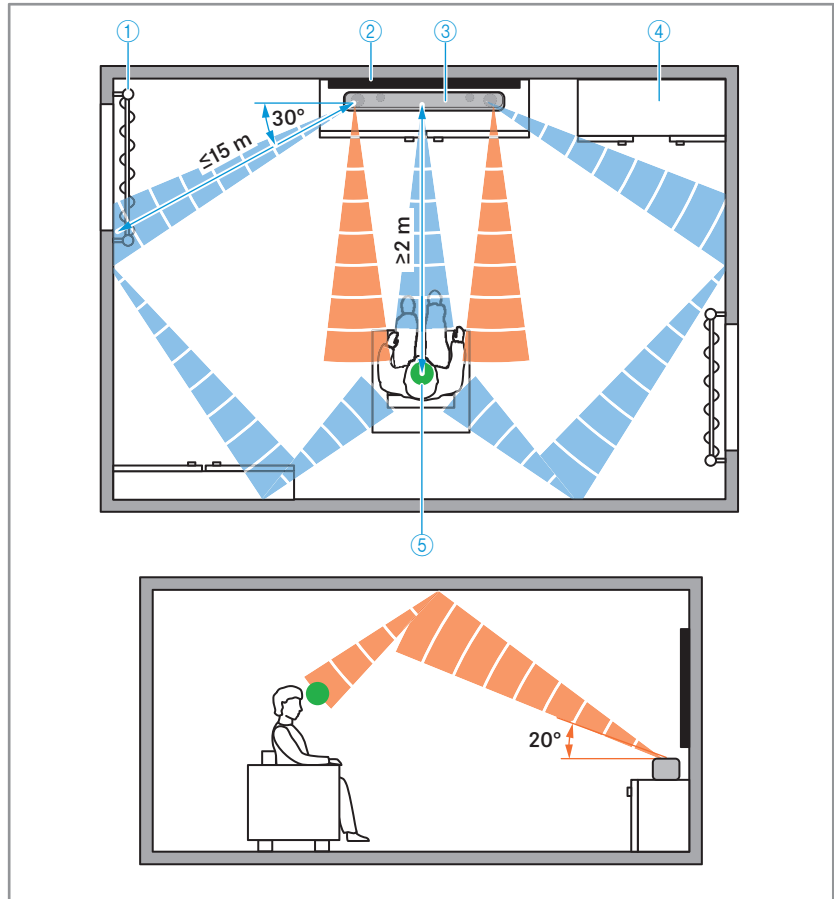

- ① Curtain
- ② TV
- ③ Soundbar
- ④ Furniture
- ⑤ Optimal point “sweet spot”



Reflecting surface



Sound waves of the loudspeakers



Sound waves from the top-firing loudspeakers to the ceiling



When positioning the Soundbar, keep in mind that the sound is reflected by the walls and ceiling. Many curtains, thick carpets and other rough surfaces can affect the 3D spatial sound.

## Mounting the Soundbar to a wall

To mount the Soundbar to a wall, you require the SB02-WM wall mount (optional accessory, > 15) for the AMBEO Soundbar | Plus.

- ▷ Proceed as described in the mounting instructions (enclosed with the SB02-WM wall mount).

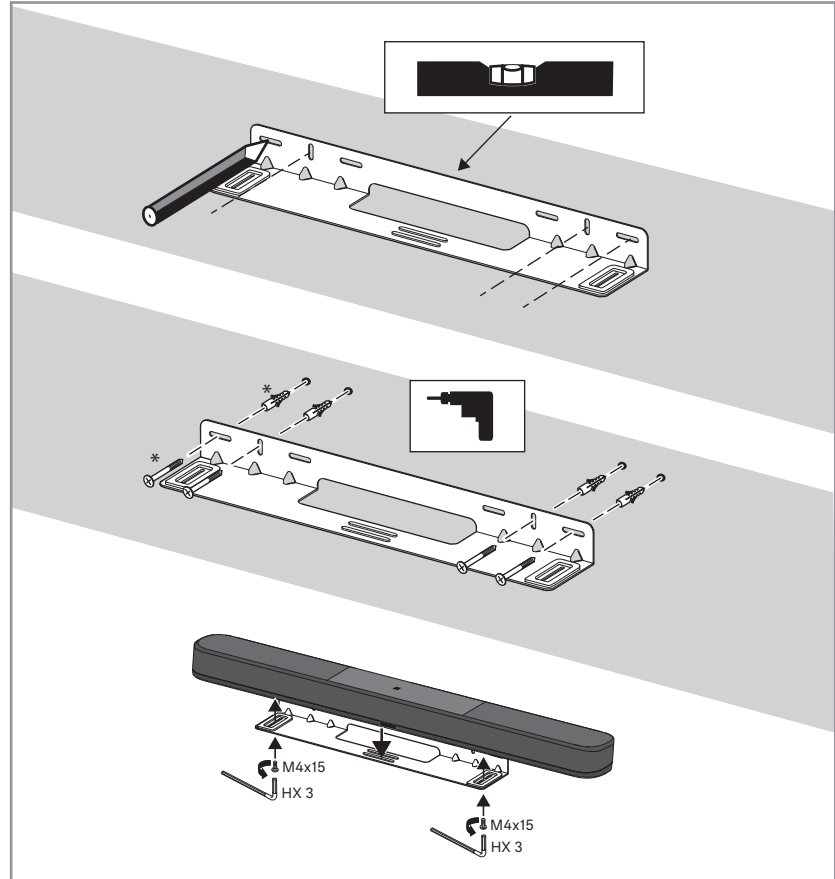

## Placing a Sub on the device feet and positioning it

### ATTENTION

#### Risk of staining of furniture surfaces!

Varnish or furniture polish may degrade the feet of the product, which could stain your furniture.

▷ Do not place the product on delicate surfaces; if necessary, use a non-slip pad under the product.

▷ Place the Sub on the floor. The floor has to be firm and level.

▷ Observe the following:

- The subwoofer should be placed to the side of the Soundbar. The distance to walls should be approx. 5.90"/15 cm.
- The transmission range between the subwoofer and the Soundbar is up to 10 m.
- The radiation angle of the subwoofer leads upwards. Do not place any objects on top of the subwoofer and do not cover it.
- If you are using more than one subwoofer (up to 4 are possible), place the subwoofers on one side/wall. It is possible to distribute the subwoofers in the room instead, but in this case the bass performance may not build up optimally.
- Placing the subwoofer in the front area of the room will result in optimal sound mixing between the speakers.
- Placing the subwoofer in the rear area of the room minimizes the localization effect.

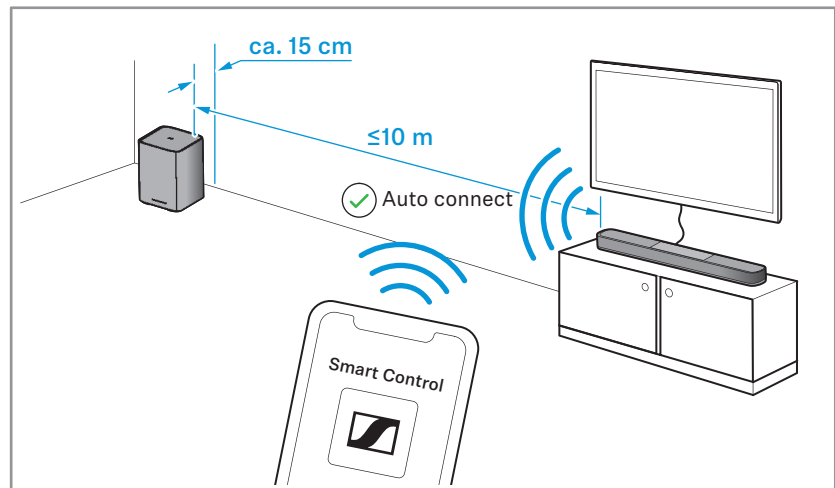

## Setting up the Soundbar and a Sub

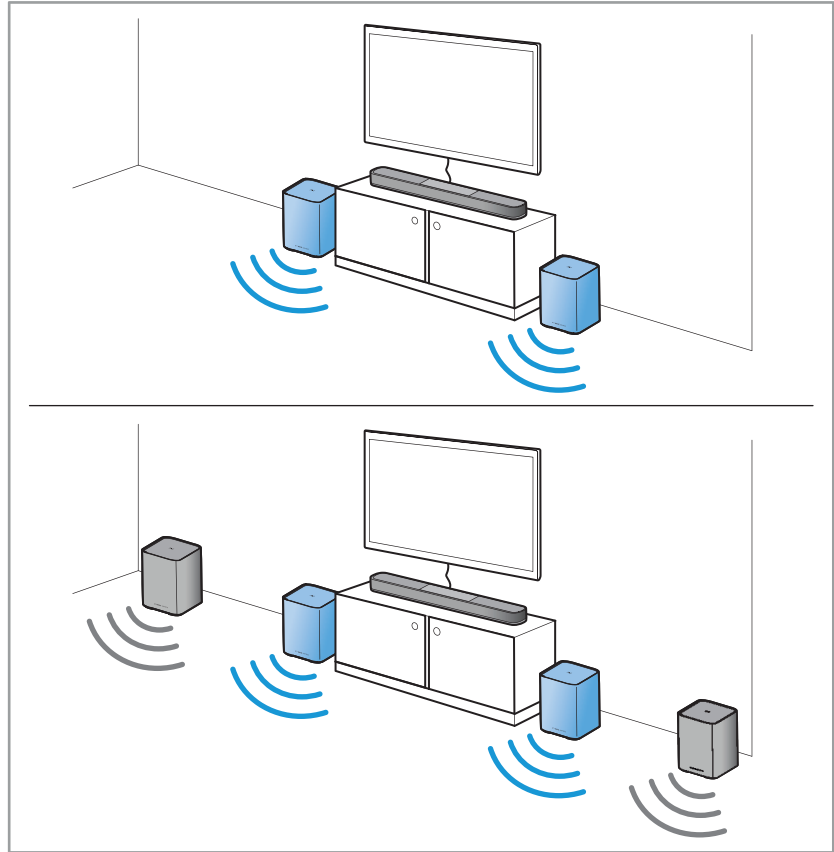

## Connecting devices to the Soundbar

- ▷ Put a protective material (e.g. a blanket) between the piece of furniture and the Soundbar.
- ▷ Carefully turn the Soundbar on its front.

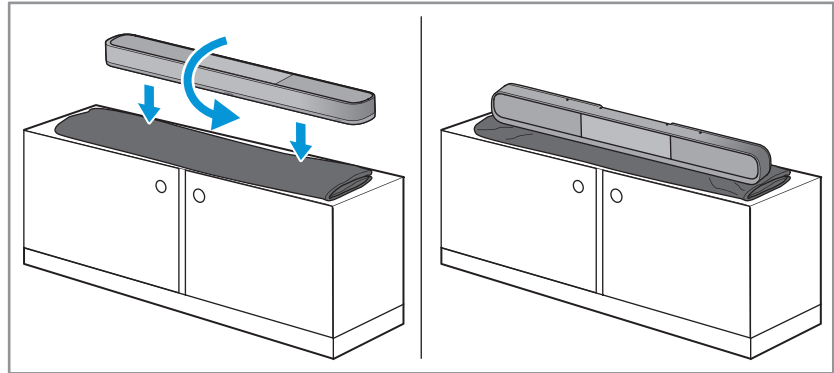





## Preparation

Adjust the sound settings on the TV and on the audio/video device.

- ▷ On your devices, adjust the sound settings for the HDMI output and the optical output from “Downmix/Stereo” to “Auto/Bypass/Pass-Through”. (The menu of the devices may use different names depending on the manufacturer).

This ensures that the audio signals for 3D spatial sound from the source (e.g. TV) are passed on to the AMBEO Soundbar.

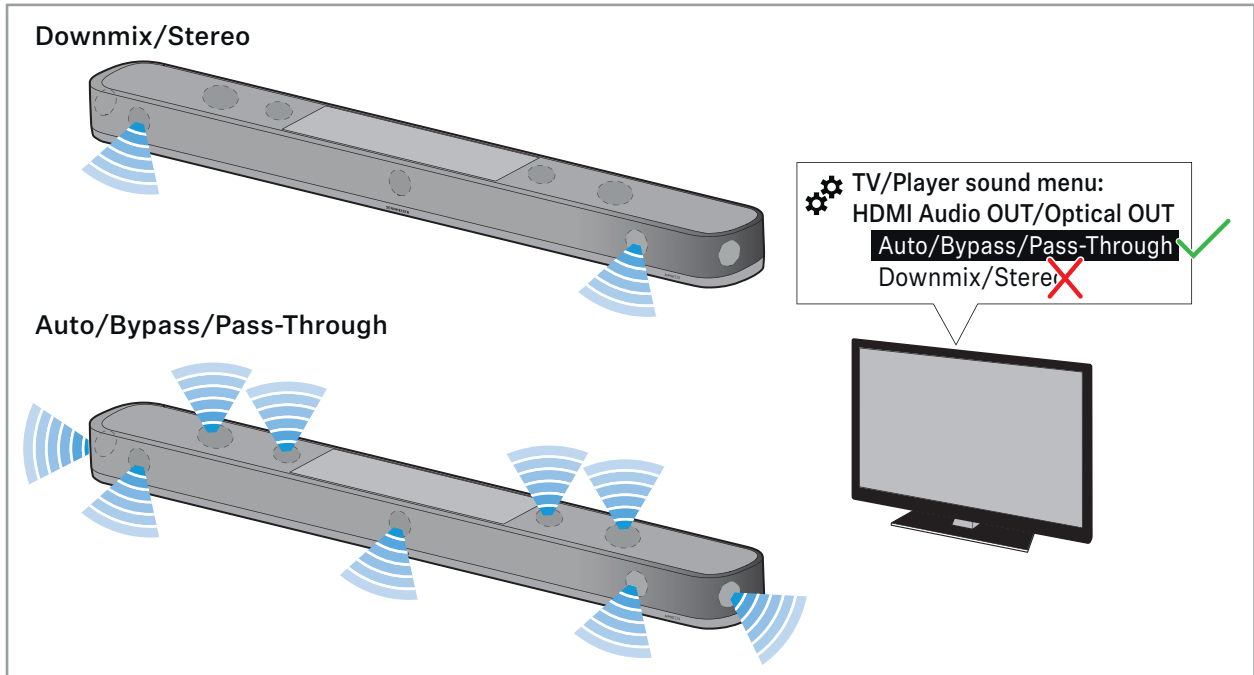

## Connecting a TV

### Connection to the HDMI eARC socket (recommended)

Required cable: Premium High-Speed HDMI Cable (supplied)

To connect the Soundbar to a TV with an HDMI IN socket labeled “ARC/eARC”:

- ▷ Connect one connector of the supplied Premium High-Speed HDMI Cable to the **HDMI TV (eARC)** socket on the Soundbar.
- ▷ Connect the other connector of the cable to the HDMI (eARC) IN socket of your TV.
- ▷ Observe the settings of your devices (> 29).

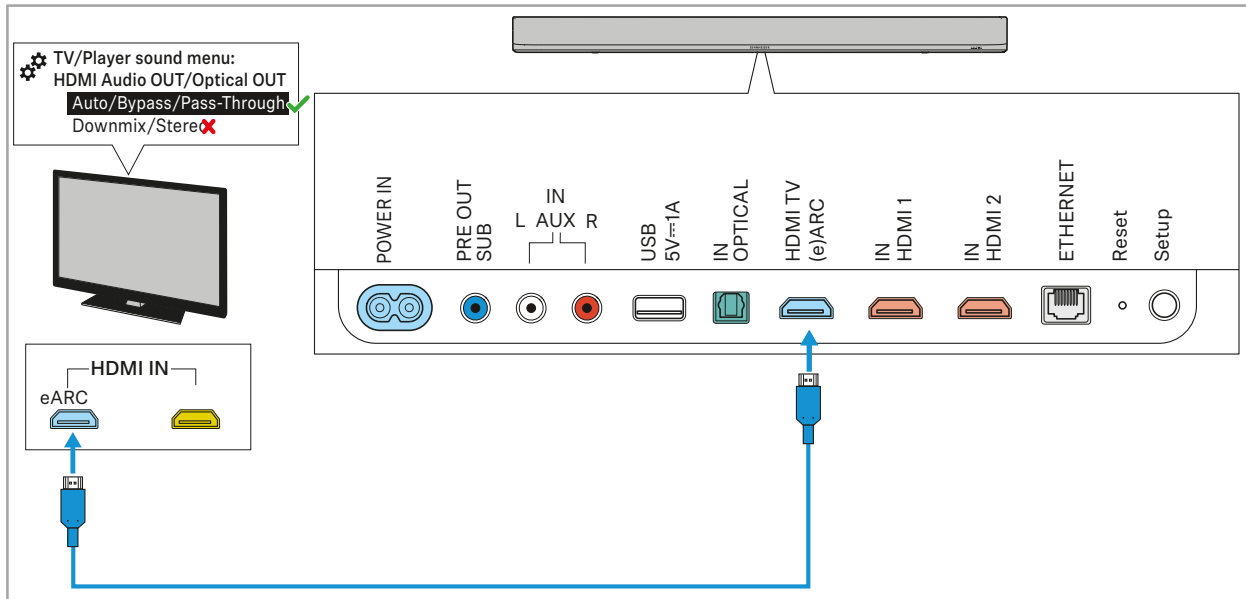

## Connecting devices to the Soundbar

### Connection without HDMI eARC socket

Required cable: optical cable (recommended length: max. 5 m)

To connect the Soundbar to a TV without an HDMI IN socket labeled “ARC/eARC”:

- ▷ Connect one connector of an optical cable (to be ordered separately) to the **OPTICAL IN** socket on the Soundbar.
- ▷ Connect the other connector of the cable to the **OPTICAL OUT** socket on your TV.
- ▷ Observe the settings of your devices (> 29).

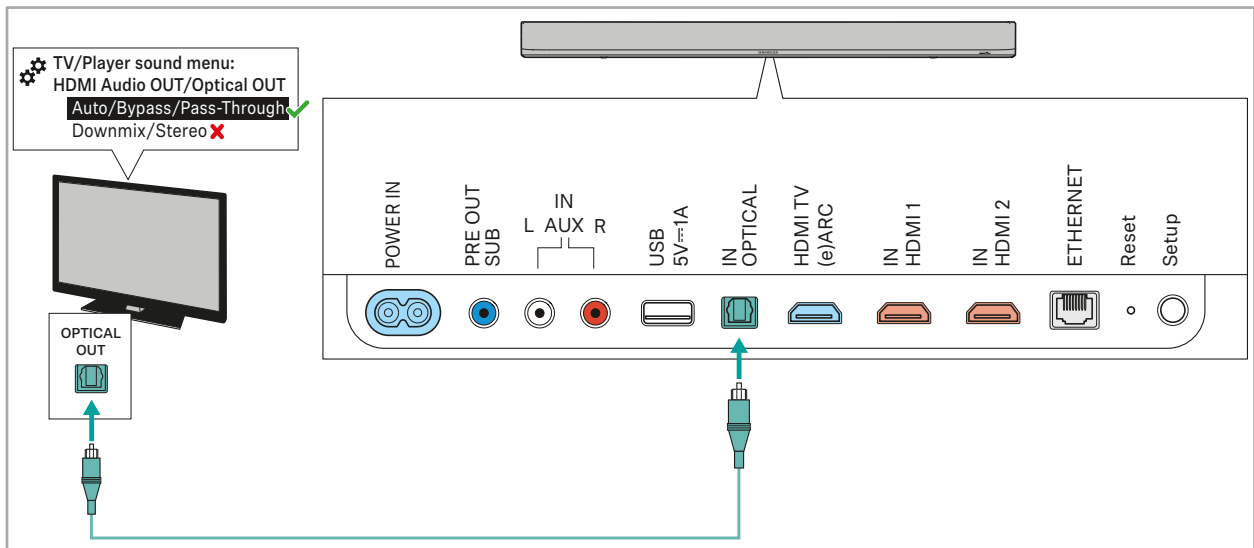

## Connecting an audio/video device

### Digital connection

Required cable: HDMI (recommended: at least Premium High-Speed HDMI Cable)

To connect the Soundbar to an audio source (e.g. Blu-ray player, DVD player):

- ▷ Connect one connector of an HDMI cable (to be ordered separately) to one of the two HDMI sockets (**HDMI 1 IN**, **HDMI 2 IN**) on the Soundbar.
- ▷ Connect the other connector of the cable to the HDMI OUT socket of your audio source.
- ▷ Observe the settings of your devices (> 29).

**i** Video contents with a resolution of 8K cannot be transmitted to the Soundbar. Connect your video device directly to your TV if you want to transmit video contents in 8K.

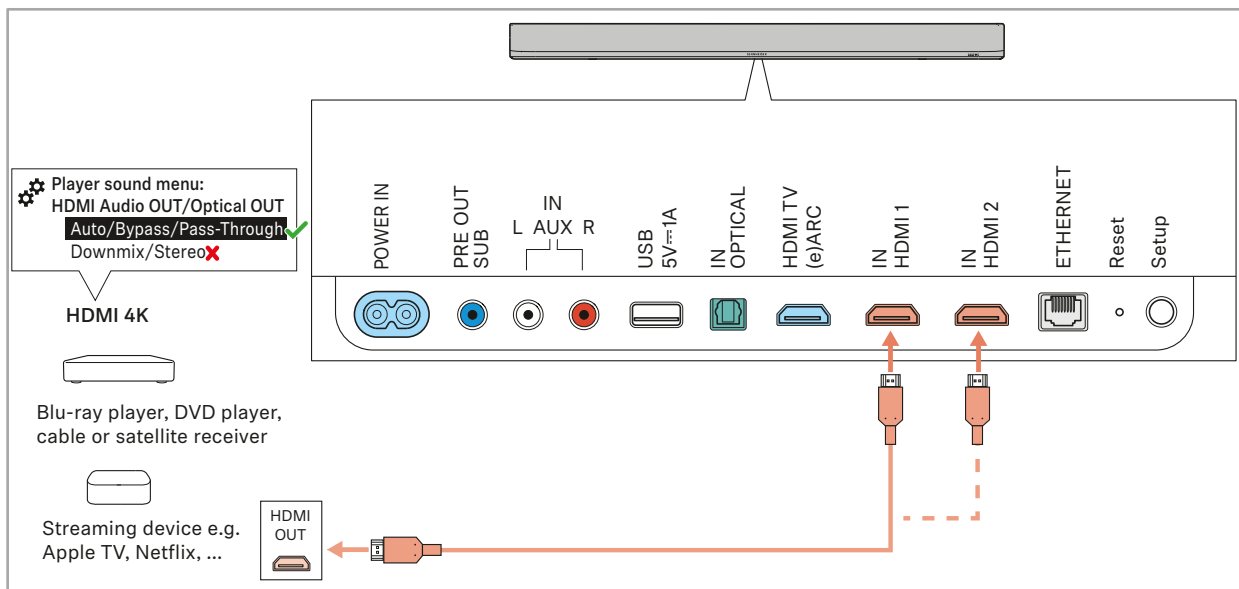

## Connecting devices to the Soundbar

### Analog connection

Required cable: stereo RCA cable

To connect the Soundbar to a TV or an audio source (e.g. CD player):

- ▷ Connect the red connector of an RCA cable (to be ordered separately) to the red **AUX IN R** socket and the white connector of the same cable end to the white **AUX IN L** socket on the Soundbar.
- ▷ Connect the other red connector of the cable to the red socket and the white connector of the same cable end to the white socket of the TV or audio source.

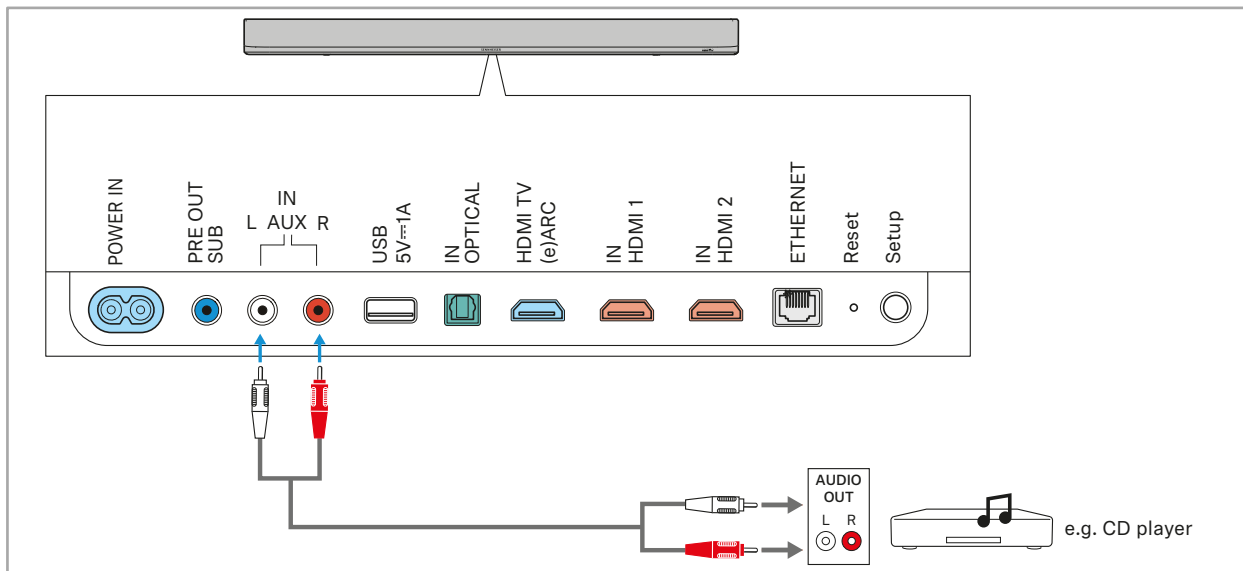

## Connecting an Ethernet cable

To connect the Soundbar to a wired network:

- ▷ Connect one connector of a network cable (with RJ-45 connector, to be ordered separately) to the **ETHERNET** socket on the Soundbar.
- ▷ Connect the other connector of the cable to the network socket of your router.  
You may have to make settings on your router.

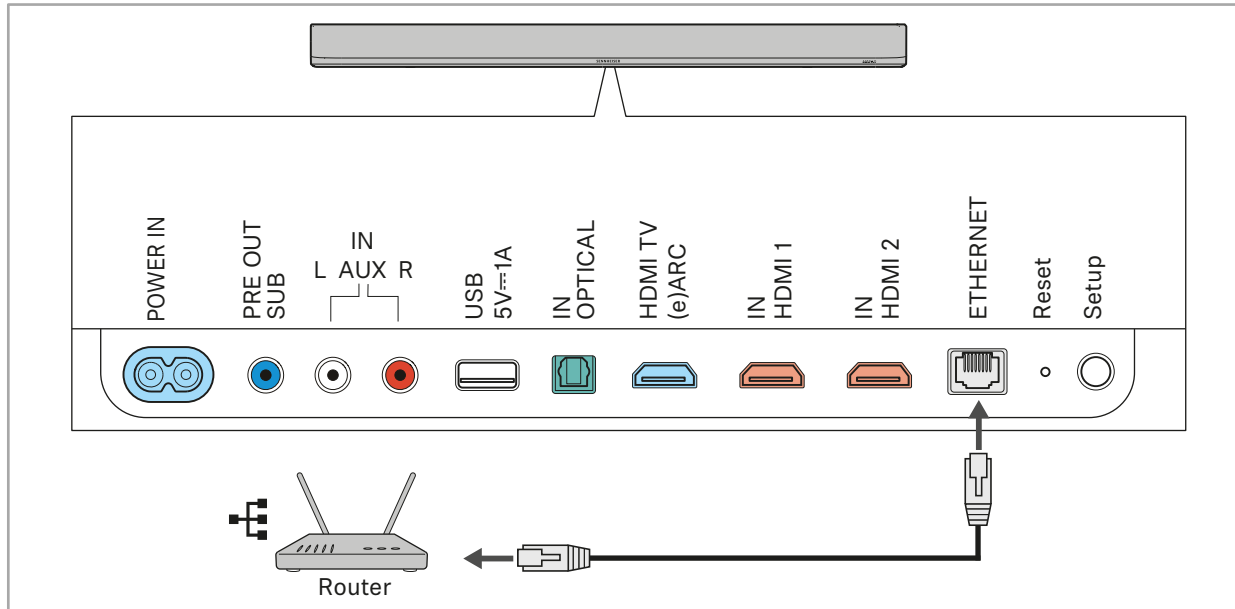

If you connect the Soundbar to the Internet/Ethernet via cable, the WiFi function of the Soundbar is automatically deactivated.

Alternatively, the Soundbar can be connected to the Internet via WiFi (> 53).

## Connecting a subwoofer (optional)

Optionally, you can connect a subwoofer to the Soundbar.

### Analog connection

Required cable: mono RCA cable

- ▷ Recommended settings: Adjust the volume on the subwoofer to “approx. 50%” and set the crossover to “Max”.
- ▷ Connect one connector of the mono RCA cable (to be ordered separately) to the **PRE OUT SUB** socket on the Soundbar.
- ▷ Connect the other connector of the cable to the socket **LOW LEVEL IN/MONO** of the subwoofer.

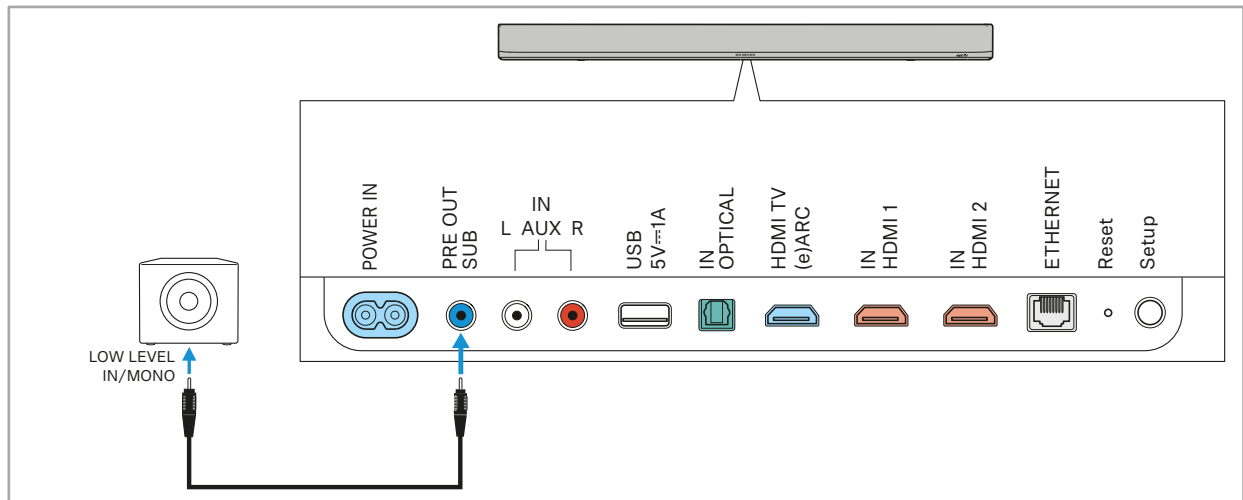

### Wireless connection (with AMBEO Sub only)

You can wirelessly connect up to 4 AMBEO Subs to the Soundbar. You can set up and manage the wireless connections of all AMBEO Subs via the Sennheiser Smart Control app (> 57). To do so, the Smart Control app has to be installed on your smartphone and connected to the Soundbar.

If the Smart Control app is not available, you can establish the wireless connection via the Setup button on the Soundbar.

- ▷ Make sure that the Soundbar and the AMBEO Sub are connected to the power supply (> 38, > 39).

Upon delivery, the AMBEO Sub is automatically in pairing mode and searches for a new connection. During this process, the Status LED of the AMBEO Sub pulses yellow.

- i** If the AMBEO Sub's Status LED pulses white instead, the AMBEO Sub is searching for an already known connection to a device with which the AMBEO Sub has already been paired once. To delete this known connection, you have to reset the AMBEO Sub. (> 37).

- ▷ Briefly press the Setup button of the Soundbar. The Soundbar connects to the AMBEO Sub. The Status LED of the AMBEO Sub lights up white after a successful connection.

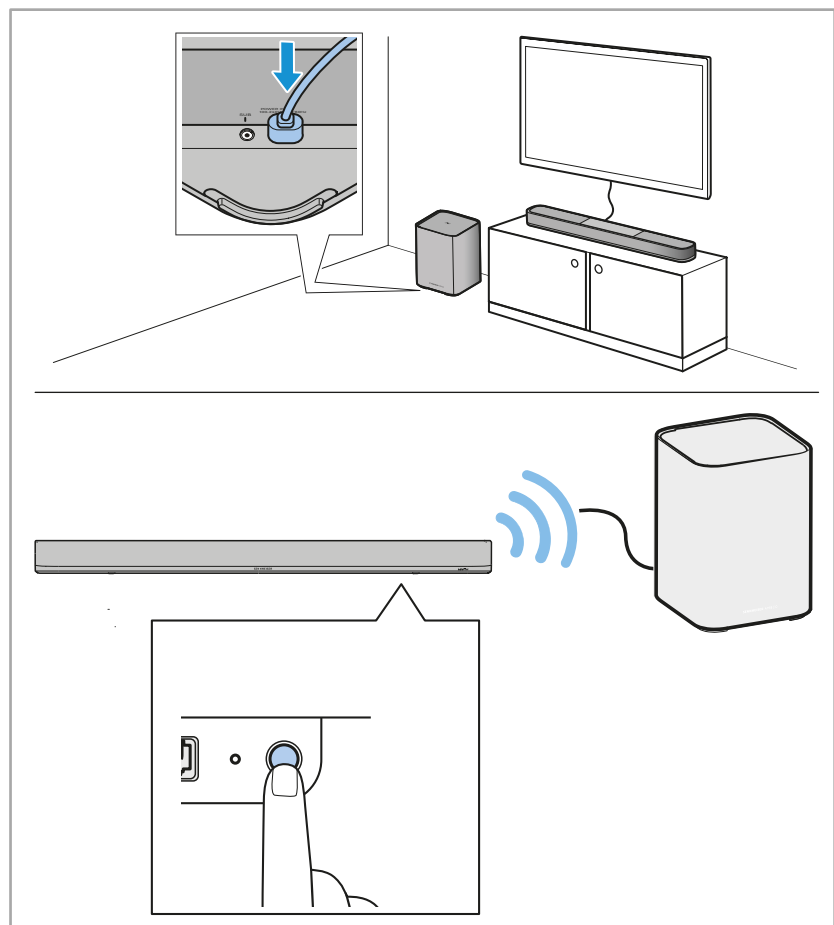

- ▷ If necessary, connect additional AMBEO Subs in the same way.
- ▷ Calibrate the Soundbar (> 41).



### Deleting the pairing settings of the AMBEO Sub

If the AMBEO Sub is already paired with a device, the AMBEO Sub's Status LED will pulse white instead of yellow during the connection search. The AMBEO Sub automatically tries to pair with the known device.

To be able to connect the AMBEO Sub to a new device, you have to delete the known pairing settings.

You can delete the pairing settings of all connected AMBEO Subs directly via the Smart Control app (> 58).

Alternatively, you can reset the pairing settings via the Setup button of the AMBEO Sub.

To reset the AMBEO Sub via the Setup button:

- ▷ Press the Setup button of the AMBEO Sub for 3 seconds.  
The Status LED of the AMBEO Sub flashes orange 3x and then pulses yellow. The AMBEO Sub searches for a new connection.  
If you reset the pairing settings of the AMBEO Sub via the Setup button, you then have to manually delete the pairing settings of the AMBEO Sub from the Sennheiser Smart Control app (> 58).  
After you have deleted the pairing settings of the AMBEO Sub, you have to perform a room calibration (> 41).

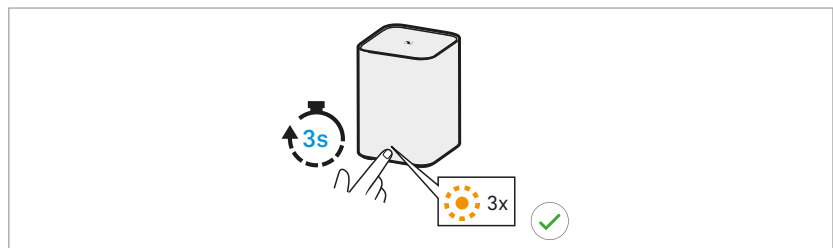

### Disconnecting the subwoofer

As long as the subwoofer is connected to the Soundbar, you can deactivate it in the Sennheiser Smart Control app. In doing so, you can prevent a subwoofer from being used during audio playback without having to disconnect the subwoofer from the Soundbar (> 58).

When the subwoofer is deactivated, the Soundbar uses the room calibration data without subwoofer, if there is one.

## Connecting/disconnecting the Soundbar to/from the power supply system



### ATTENTION

**Danger of damage to the product!**

If you connect to an unsuitable power supply, the product can be damaged.

- ▷ Use a suitable power cable to connect the product to the power supply system (100 – 240 V, 50 Hz/60 Hz).

### Connecting to the power supply system

- ▷ Connect the plug of the power cable to the **POWER IN** socket on the Soundbar.
- ▷ Connect the power plug of the power cable to a suitable wall socket.  
The Soundbar automatically switches on after being connected to the power supply.  
The LED status bar of the Soundbar lights up white.

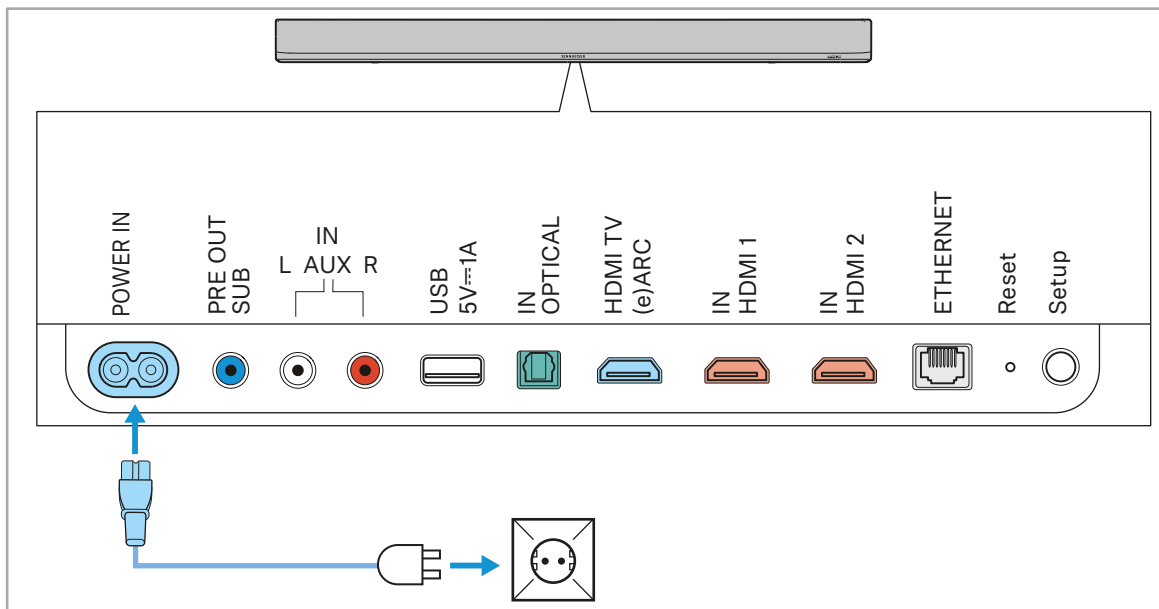

### Disconnecting from the power supply system

- ▷ Disconnect the power plug of the power cable from the wall socket.
- ▷ Disconnect the plug of the power cable from the **POWER IN** socket on the Soundbar.



The Soundbar does not have to be switched on or off manually. When the Soundbar is not in use, it automatically switches to the power-saving ECO mode (> 46). The Soundbar automatically switches on from ECO mode when you start audio playback from an audio source.

Alternatively, you can put the Soundbar in standby mode without network connection (> 46).

## Connecting/disconnecting an AMBEO Sub to/from the power supply system



### ATTENTION

**Danger of damage to the product!**

If you connect to an unsuitable power supply, the product can be damaged.

- ▷ Use a suitable power cable to connect the product to the power supply system (100 – 240 V, 50 Hz/60 Hz).

### Connecting to the power supply system

- ▷ Connect the plug of the power cable to the **POWER IN** socket on the AMBEO Sub.
- ▷ Connect the power plug of the power cable to a suitable wall socket.  
The AMBEO Sub automatically switches on after being connected to the power supply.  
The Status LED of the AMBEO Sub lights up white.

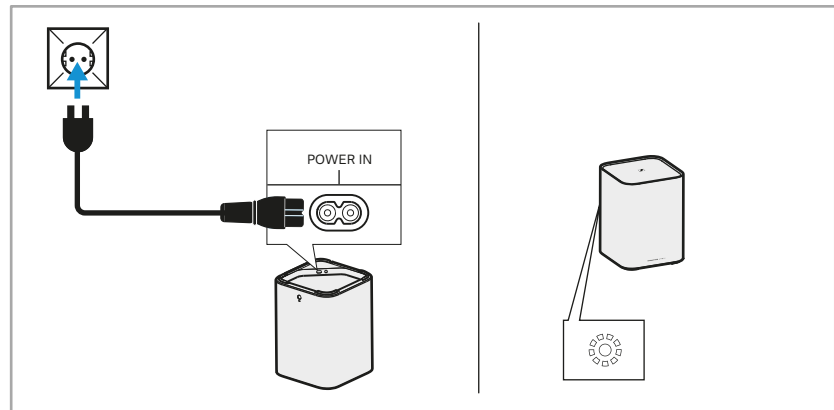

### Disconnecting from the power supply system

- ▷ Disconnect the power plug of the power cable from the wall socket.
- ▷ Disconnect the plug of the power cable from the **POWER IN** socket on the AMBEO Sub.



The AMBEO Sub does not have to be switched on or off manually. If the AMBEO Sub is wirelessly connected to the Soundbar and the Soundbar switches to ECO mode, the AMBEO Sub automatically switches to standby mode after 5 minutes. If the AMBEO Sub is connected to the Soundbar via cable, the AMBEO Sub will only switch to standby mode after 15 minutes. The AMBEO Sub automatically switches on from standby mode as soon as you start audio playback via the Soundbar.

## Putting the Soundbar into operation

### Preparing the SB02-RC remote control

To remove the transport protection of the battery:

- ▷ Use a suitable object (e.g. a coin) to open the battery compartment cover (located on the bottom side of the remote control) by turning one turn counter-clockwise.
- ▷ Remove the plastic strip.
- ▷ Close the battery compartment cover by turning one turn clockwise.

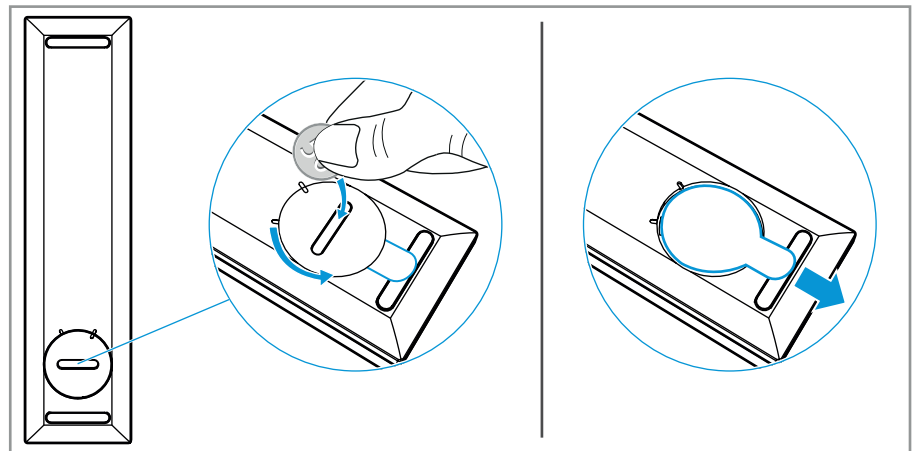

### Installing the Sennheiser Smart Control app

To be able to control the Soundbar using a smartphone, the Soundbar and the smartphone on which you install the Sennheiser Smart Control app has to be connected to the same WiFi network.

To make full use of all the settings and functions of the AMBEO Soundbar, you have to have the free Sennheiser Smart Control app installed on your smartphone.

- ▷ Download the Sennheiser Smart Control app from the Apple App Store or from Google Play and install it on your smartphone. Alternatively, you can visit the following website: [www.sennheiser-hearing.com/smartcontrol](http://www.sennheiser-hearing.com/smartcontrol)

#### Establishing the initial connection between the Sennheiser Smart Control app and the Soundbar

The initial connection between the Sennheiser Smart Control app and the Soundbar is established via Bluetooth Low Energy. For this, Bluetooth has to be activated on your smartphone.

After the initial connection via Bluetooth is established, you can set up a WiFi connection for the Soundbar in the Smart Control app. In doing so, the Smart Control app can then connect to the Soundbar via WiFi (> 53).

- ▷ Make sure that the Soundbar is properly connected to the power supply.
- ▷ Make sure that the smartphone you want to connect to has the Smart Control app installed and Bluetooth and WiFi are activated.
- ▷ Start the Smart Control app.
- ▷ Follow the instructions in the Smart Control app.  
The Smart Control app recognizes the Soundbar and activates all available settings and functions.



If the initial connection between the Smart Control and the Soundbar via Bluetooth fails, the Soundbar may have already been paired with the smartphone via Bluetooth.

In this case, you have to delete all entries of the Soundbar in the Bluetooth menu of the smartphone.

Then start a new connection attempt.

### Configuring the Soundbar without the Sennheiser Smart Control app

- ▷ Connect your smartphone or computer to the Soundbar's WiFi hotspot.  
The Soundbar's WiFi network name is "AMBEO Soundbar [serial number]".
- ▷ Go to the Soundbar page in your web browser  
(address: <http://192.168.255.249/>  
or, if the Soundbar and your smartphone or computer are on the same network, go to: <http://ambeo>).

## Starting the room calibration

The room calibration is necessary for the measurement of the room in order to let you get the optimum spatial sound experience.

Therefore, the room calibration should be performed when

- the Soundbar is put into operation for the first time in a room,
- the position of the Soundbar has been changed,
- a subwoofer has been connected or disconnected, or
- the room has been changed (e.g. furniture has been moved).

### Preparing the calibration

- ▷ Connect the Soundbar to the power supply system (> 38).
- ▷ The Soundbar switches on. This process takes about 20 seconds.  
The LED status bar lights up white.
- ▷ Make sure that the microphones of the Soundbar are not muted (> 48).
- ▷ Make sure that the subwoofers are set up correctly and connected to the power supply system (> 25, > 39).
- ▷ Make sure that it is quiet in the room where you calibrate the Soundbar.

### Starting the calibration

You can start the calibration either via the Sennheiser Smart Control app or via the Volume + and Volume - buttons on the Soundbar.

The Smart Control app allows you to check the status of the calibration in progress.

To start the calibration via the Sennheiser Smart Control app:

- ▷ Open the Smart Control app.
- ▷ In the **System Calibration** section, tap the **Start** button and follow the on-screen instructions.

To start the calibration via the Soundbar's Volume + and Volume - buttons:

- ▷ Simultaneously press the Volume + and Volume - buttons for 3 seconds.

The calibration process takes several minutes. The calibration of the Soundbar takes longer if connected subwoofers are calibrated as well.

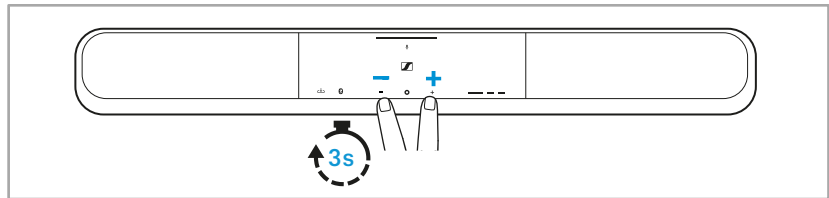

- ▷ Avoid interfering noises during calibration (open windows, household appliances, etc.), do not stand too close to the Soundbar and do not cover the Soundbar's microphones, as this can falsify the calibration.  
After the calibration is complete, the Soundbar plays a demo tune.

### Canceling the calibration

To cancel the calibration:

- ▷ Press the Multi-purpose **o** button on the Soundbar for 3 seconds.  
The LED status bar lights red.  
The Soundbar is in an uncalibrated state and has to be recalibrated.

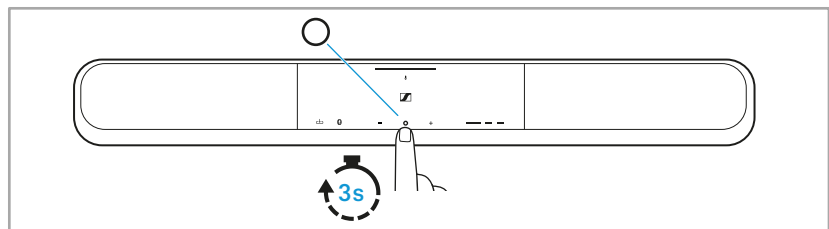

## Operating the Soundbar



---

### WARNING

#### Danger due to high volume levels!

Listening at high volume levels can lead to permanent hearing defects.

- ▷ Adjust the volume to a low level before selecting a source.
  - ▷ Do not continuously expose yourself to high volume levels.
- 

## Switching the Soundbar on and off

The Soundbar automatically switches on after being connected to the power supply.



The Soundbar does not have an on/off button to switch the Soundbar off. When you are not using the Soundbar, it will automatically switch to ECO mode (> 46).

When audio playback is started from an input source, the Soundbar automatically switches on from ECO mode and plays back the input source.



If an AMBEO Sub that is in standby mode is wirelessly connected to the Soundbar, the AMBEO Sub will automatically switch on when you start audio playback from the Soundbar.

## Functions of the Multi-purpose button

The Soundbar and the remote control of the Soundbar are equipped with the Multi-purpose  button. Which function is started by pressing the Multi-purpose  button depends on how often you press the button in quick succession and whether the Amazon Alexa voice assistant is activated. You can activate Amazon Alexa via the Sennheiser Smart Control app.

### Functions of the Multi-purpose button with the Amazon Alexa voice assistant deactivated

Button	Condition	Function
Press 1x	No playback of audio contents	Starts audio playback
	Audio playback in progress via input sources that allow control of a playback progress bar (e.g. streaming via Bluetooth or network connection)	Pauses audio playback
	Audio playback in progress via input sources that do not allow control of a playback progress bar (e.g. analog AUX input sources such as CD players)	Mutes the Soundbar When sound is played back through an HDMI input, the sound may be played back through the TV's speakers after the Soundbar is muted, depending on the input source settings.
Press 2x	Audio playback in progress via input sources that allow control of a playback progress bar (e.g. streaming via Bluetooth or network connection)	Plays the next track in the playlist
Press 3x	Audio playback in progress via input sources that allow control of a playback progress bar (e.g. streaming via Bluetooth or network connection)	Plays the previous track in the playlist



Functions of the Multi-purpose o button with the Amazon Alexa voice assistant activated

Button	Condition	Function
Press 1x	–	Triggers Amazon Alexa or cancels a command to Amazon Alexa.
Hold for 3 sec	No playback of audio contents	Starts audio playback
	Audio playback in progress via input sources that allow control of a playback progress bar (e.g. streaming via Bluetooth or network connection)	Pauses audio playback
	Audio playback in progress via input sources that do not allow control of a playback progress bar (e.g. analog AUX input sources such as CD players)	Mutes the Soundbar When sound is played back through an HDMI input, the sound may be played back through the TV's speakers after the Soundbar is muted, depending on the input source settings.

## Standby/ECO mode

If there is no audio playback for at least 10 seconds, the Soundbar switches to the power-saving ECO mode. The AMBEO logo on the Soundbar dims and the ECO button appears in the Sennheiser Smart Control app.

If you want to pause audio playback, you have the following options:

- Briefly press the Multi-purpose **o** button on the Soundbar or the remote control.
- Tap the Pause button in the playback area of the Smart Control app.
- Stop playback at the input source.

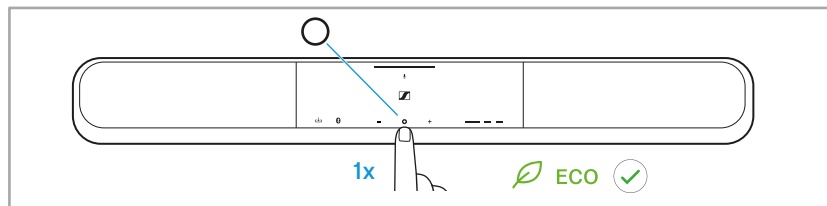

If an AMBEO Sub is wirelessly connected to the Soundbar, the AMBEO Sub automatically switches to standby mode after 5 minutes when the Soundbar switches to ECO mode. If the AMBEO Sub is connected via cable, the AMBEO Sub will only switch to standby mode after 15 minutes.

## Activating/deactivating standby mode without network connection

You can manually put the Soundbar into standby mode without a network connection. Compared to ECO mode, this also disconnects all network connections of the Soundbar.

If the Soundbar is in standby mode without a network connection, it cannot switch on again automatically. You have to manually deactivate the standby mode without network connection.

To activate standby mode without network connection:

- ▷ Simultaneously press the Multi-purpose **o** button and the Volume **-** button on the Soundbar or the remote control and hold the buttons for 5 seconds.

If you want to deactivate standby mode without network connection, you have the following options:

- Briefly press the Multi-purpose **o** button.
- Briefly press the **Source** button.

Since the network connections have to be restored when you switch the Soundbar on again, the switch-on process may take up to one minute.

## Adjusting the volume



---

### WARNING

#### Danger due to high volume levels!

Listening at high volume levels can lead to permanent hearing defects.

- ▷ Adjust the volume to a low level before selecting a source.
  - ▷ Do not continuously expose yourself to high volume levels.
- 

### Adjusting the volume on the Soundbar or via the remote control

To decrease or increase the volume in small increments:

- ▷ Briefly press the Volume + button or the Volume – button 1x.

To decrease or increase the volume in large increments:

- ▷ Press the Volume + button or the Volume – button until the desired volume is reached.

### Adjusting the volume in the Sennheiser Smart Control app

In the Sennheiser Smart Control app, you can only adjust the volume after an audio source has been selected.

- ▷ Move the volume slider in the playback area of the Smart Control app with a swiping motion.

## Activating/deactivating the mute function

### Activating/deactivating the mute function of the loudspeakers

If you want to activate the mute function, you have the following options:

- Press the Multi-purpose **o** button on the Soundbar or the remote control. Depending on the settings of the input source, audio may then be played back via the loudspeakers of the input source (e.g. TV).
- Activate the mute function on the input source (e.g. with the TV remote control).
- Reduce the volume to 0 (see > 47).

If you want to deactivate the mute function, you have the following options:

- Press one of the mute buttons again.
- Adjust a volume > 0 (> 47).

### Activating/deactivating the mute function of the microphones

The Soundbar features 4 microphones for calibrating the Soundbar and controlling the Soundbar with a voice assistant.

When you mute the microphones, the microphones are disconnected from the power supply. This prevents the microphones from being used unintentionally.

You have to deactivate the muting of the microphones if

- you want to calibrate the Soundbar or
- you want to use the Soundbar with a voice assistant.

To mute or unmute the microphones:

- ▷ Press the **Mic Mute** button on the Soundbar.

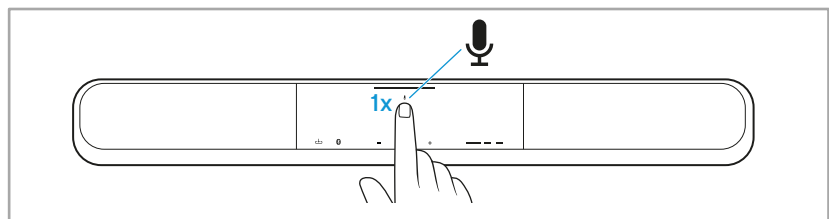

When the microphones are muted, the Mic LED lights up red.

## Selecting the input source



### WARNING

**Danger due to high volume levels!**

Listening at high volume levels can lead to permanent hearing defects.

- ▷ Adjust the volume to a low level before selecting a source.
- ▷ Do not continuously expose yourself to high volume levels.

### Selecting the input source via the Sennheiser Smart Control app

- ▷ Open the Smart Control app.
- ▷ At the top of the playback area in the Smart Control app, tap the **Input source** button.

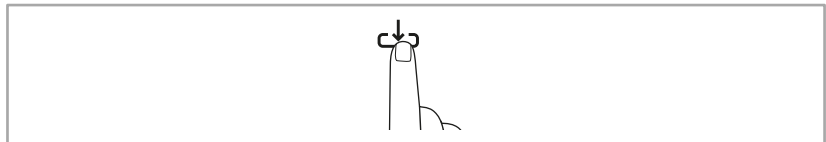

A list of available input sources is displayed.

If a sound signal is present at the input, a loudspeaker symbol is also displayed.

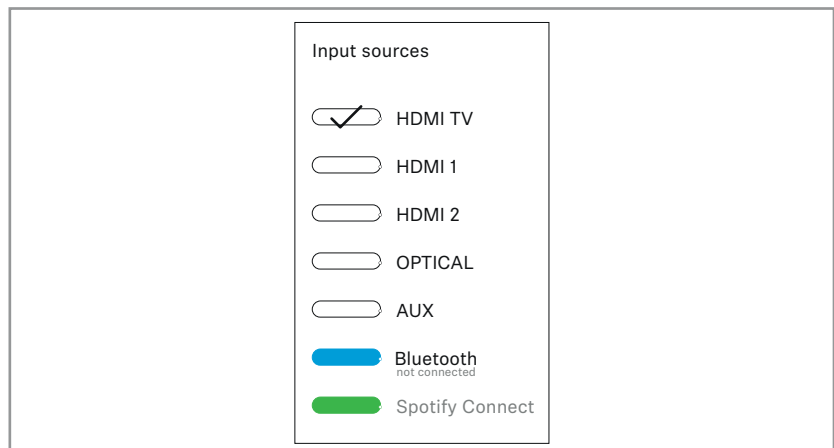

- ▷ Tap the desired input source.

### Selecting the input source via the Soundbar

- ▷ Use the **Source** button to switch between the available input sources.

The **Source** button switches only between connected and switched-on input sources.

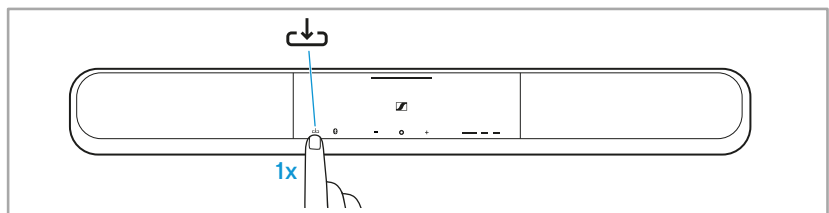

If only one input has a switched-on sound source connected, the input source cannot be changed. The LED status bar then flashes red.

### Selecting the input source via the remote control

- ▷ Use the **Source +** and **Source –** buttons to switch between the available input sources.  
The **Source +** and **Source –** buttons switch only between connected and switched-on input sources.

### Streaming sources

Streaming sources (e.g. Tidal Connect), with the exception of Spotify Connect, cannot be selected using the **Source** button.

If you are using Spotify Connect, you can use the **Source** button to access the most recent playlist.

The Soundbar automatically switches to the streaming source when playback is started from a streaming service.

If the streaming source is disconnected, the Soundbar jumps back to the previous source.

 You can also have the Spotify Connect streaming service start automatically when you switch on the Soundbar and then select it as the input source using the **Source** button.

To do so, activate the “Auto-play Function” function in the **Spotify Connect** submenu of the **Services** menu via the Sennheiser Smart Control app (> 62).

### Customizing the name and color of the input source

If you have selected an input source, the name of the input source is displayed in the playback area of the Smart Control app. You can change the name of the input source, except for the input sources Bluetooth and Spotify Connect, in the Smart Control app.

You can also assign a color to each input source, except for the input sources Bluetooth and Spotify Connect. The LED status bar of the Soundbar lights up in the color of the active input source.

- ▷ Open the Smart Control app.
- ▷ At the very top of the header of the Sennheiser Smart Control app, tap the **Settings** menu.
- ▷ In the **Settings** menu, tap the **Input** button.  
A drop-down list appears.
- ▷ Tap the **Input names** item in the drop-down list.
- ▷ Tap the pencil icon next to the input source whose name or LED color you want to change.
- ▷ Type a name in the input field or tap the desired LED color.
- ▷ Confirm your selection with the **OK** button.

You cannot customize the input sources Bluetooth and Spotify Connect.

## Using the Soundbar

### Connecting the Soundbar to a Bluetooth device

#### Information on the Bluetooth wireless connection

The Soundbar is compatible with the Bluetooth standard 5.0.

If your audio source supports the high-resolution audio encoding method AAC, music is automatically played back in high audio quality. Otherwise the Soundbar will play back your music in normal audio quality (SBC).

When selecting the “Bluetooth” input or when switching on with the last used input “Bluetooth”, the Soundbar automatically tries to connect to the last used Bluetooth device.

The Soundbar can save the connection profiles of up to six Bluetooth devices with which it has been paired.

If you pair the Soundbar with the seventh Bluetooth device, the connection profile of the least used Bluetooth device will be overwritten. If you want to reconnect to this Bluetooth device later, you have to pair the Soundbar again.

If a device is connected, you first have to disconnect it to connect a new device.

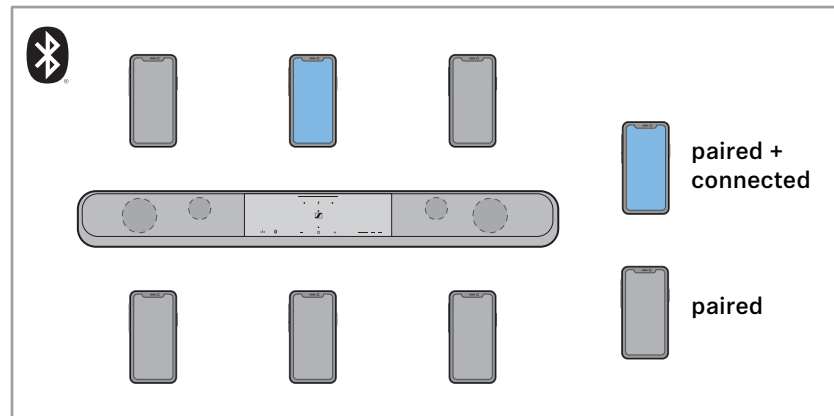

#### Pairing the AMBEO Soundbar with a Bluetooth device

To establish a Bluetooth connection without the Sennheiser Smart Control app:

- ▷ Activate Bluetooth on your Bluetooth device.
- ▷ To start the pairing mode of the Soundbar, press the Bluetooth button of the Soundbar for 3 seconds. While the Soundbar is in pairing mode, the LED status bar of the Soundbar pulses blue.

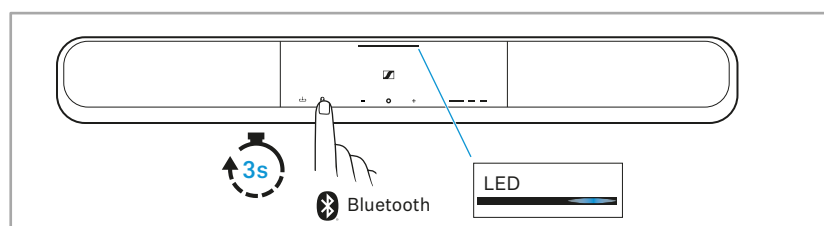

- ▷ Hold your Bluetooth device at a distance of approx. 7.87"/20 cm to the Soundbar.
- ▷ Via the menu of your Bluetooth device, start the search for new Bluetooth devices.  
All active Bluetooth devices in the proximity of your smartphone are displayed.
- ▷ From the list of found Bluetooth devices, select "AMBEO Soundbar". If necessary, enter the default pin code "0000".  
If pairing was successful, the LED status bar lights up blue.



If no connection can be established within 3 minutes, the pairing mode is terminated. If necessary, start the pairing mode again.

To establish a Bluetooth connection with the Sennheiser Smart Control app:

- ▷ Activate Bluetooth on your Bluetooth device.
- ▷ Tap the **Network** button in the **Settings** menu of the Smart Control app.  
A drop-down list appears.
- ▷ Tap the **Bluetooth** item in the drop-down list to open the **Bluetooth** menu.  
The **Your Devices** section displays Bluetooth devices that the Soundbar has already been paired with.

The **Other Devices** section displays unpaired Bluetooth devices.

In the **Bluetooth** menu, you can either pair the Soundbar directly with one of the listed Bluetooth devices or start the pairing mode.

To pair the Soundbar directly with one of the listed Bluetooth devices:

- ▷ Tap one of the displayed Bluetooth devices in the **Your Devices** or **Other Devices** section.  
The Soundbar tries to pair with the selected Bluetooth device.

To start the pairing mode:

- ▷ Tap the **Start Bluetooth Pairing** button.

### Disconnecting the AMBEO Soundbar from a Bluetooth device

To disconnect via the Bluetooth device:

- ▷ Via the menu of your Bluetooth device, disconnect the connection to the Soundbar.

To disconnect via the Sennheiser Smart Control app:

- ▷ Tap the **Network** button in the **Settings** menu of the Smart Control app.  
A drop-down list appears.
- ▷ Tap the **Bluetooth** item in the drop-down list.
- ▷ Tap the paired device.
- ▷ Tap the **Disconnect** button to disconnect the desired Bluetooth device.



## Configuring the network connection via WiFi or Ethernet

Use the WiFi connection or the Ethernet connection for:

- controlling the Soundbar via the Sennheiser Smart Control app
- streaming via Apple AirPlay, Google Chromecast, Spotify Connect and Tidal Connect
- activating the Alexa and OK Google voice assistants
- downloading firmware updates

**i** If you connect the Soundbar to the Internet/Ethernet via cable, the WiFi function of the Soundbar is automatically deactivated.

### Establishing a WiFi connection

To establish a WiFi connection:

- ▷ Press the Setup button on the Soundbar for approx. 5 seconds. WPS (WiFi Protected Setup) is activated. The Soundbar searches for a connection.

**i** If no connection can be established within 2 minutes, the Soundbar stops searching. If necessary, start the search again.

- ▷ Press the WPS button on your router. The Soundbar connects to the WiFi.
- ▷ Note that the Soundbar has to be on the same network as the devices with which the Soundbar is to communicate.

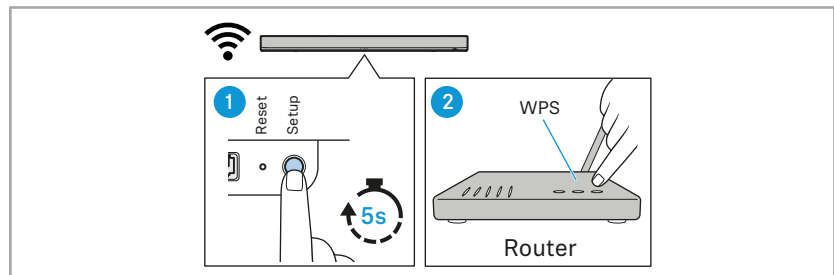

### Establishing an Ethernet connection

- ▷ Make sure that the Ethernet cable is properly connected to the Soundbar and your network (> 34).

### Managing a network connection via the Sennheiser Smart Control app

- ▷ Tap the **Network** button in the **Settings** menu of the Smart Control app. A drop-down list appears.
- ▷ Depending on the desired connection type, tap the **WiFi** or **Ethernet** item in the drop-down list.
- ▷ Adjust the WiFi connection or Ethernet connection as desired.

## Adjusting the Soundbar settings using the Sennheiser Smart Control app

You can use the Smart Control app to control your Soundbar, adjust network settings, activate streaming services and voice assistants, and adjust the sound of the Soundbar to your needs.

The most important settings of the Smart Control app are described in the following sections.

Using the [Settings](#) menu of the Smart Control app, you can view and adjust the following settings:

Menu level 1	Menu level 2	Description	Reference
Network	WiFi	Manage the WiFi connection.	> 53
	Ethernet	Manage the Ethernet connection.	
	Bluetooth	Manage the Bluetooth connection.	> 51
Audio	Calibration	Start a calibration, view the calibration status of the Soundbar or activate/deactivate the use of the room calibration data.	> 57, > 58,
	Center Settings	Adjust the Center volume.	
	Subwoofer	Manage your subwoofers (e.g. connect, disconnect, adjust bass volume).	> 57
Codec	[Codec Name] Settings	Adjust the settings of the audio codec used. Which audio codec is used is determined by the input source.	> 60

Menu level 1	Menu level 2	Description	Reference
Input	Lip sync	Adjust the latency of the audio playback to match audio and video content.	
	Input names	Assign names and LED colors to input sources.	> 50
	CEC Control	Adjust the CEC settings. With CEC, control signals from your input source are transmitted to the Soundbar.	
	Auto Wake Up In AUX	If you activate the “Auto Wake Up In AUX” function via the software switch, the Soundbar wakes up from ECO mode as soon as it receives an AUX input signal.	
	Auto Wake Up In OPT	If you activate the “Auto Wake Up In OPT” function via the software switch, the Soundbar wakes up from ECO mode as soon as it receives an optical input signal.	
User Interface	LEDs	Adjust the brightness of the LEDs.	
	Sound Feedback	Activate/deactivate the audio feedback via the software switch.	
System System	Firmware	View the current firmware version and available firmware updates.	> 69
	Language	Set the language of the Soundbar’s web browser.	> 41
	Soundbar name	Assign a name to the Soundbar.	
	Country	Set the region in which the Soundbar is operated (e.g. for WiFi settings).	
	Restart Soundbar	Restart the Soundbar.	
	Reset	Three options to reset the Soundbar: <ul style="list-style-type: none"> <li>Reset all settings of the Soundbar.</li> <li>Reset the Soundbar’s network settings.</li> <li>Reset the room calibration data.</li> </ul>	> 70
Subwoofer	Manage your subwoofers (e.g. connect, disconnect, adjust bass volume).	> 57	

Menu level 1	Menu level 2	Description	Reference
Services	Google Chromecast	Configure Google Chromecast for your Soundbar.	> 62
	Tidal Connect	Configure Tidal Connect for your Soundbar.	
	AirPlay	Configure AirPlay for your Soundbar.	
	Spotify Connect	Configure Spotify Connect for your Soundbar.	
	Add services	Configure other services such as voice assistants for your Soundbar or make additional settings for your streaming services.	> 62, > 62
Info	Licences	View license information (privacy policy, terms of use)	
	Device Information	View device information, such as serial number, network connection status, or firmware ID.	

#### Opening the “Settings” menu

- ▷ Open the Smart Control app.
- ▷ At the very top of the header of the Sennheiser Smart Control app, tap the **Settings** menu.

#### Exiting the submenu and returning to the previous menu



- ▷ Tap the arrow next to the menu name.  
The submenu closes and you return to the previous menu level.

#### Exiting the “Settings” menu

- ▷ At the very top of the header of the Sennheiser Smart Control app, tap **My Device**.

#### Using the software switches

You can activate or deactivate some functions of the Smart Control software via software switches.

Symbol	Description
	If a function is deactivated, the software switch is grayed out. If you tap the software switch, the function is activated.
	If a function is activated, the software switch is highlighted in blue. If you tap the software switch, the function is deactivated.

## Managing room calibration data via the Sennheiser Smart Control app

After you have performed a room calibration, the Soundbar can use the data obtained during the calibration to create the best possible 3D spatial sound matched to the environment.

In the Sennheiser Smart Control app, you can activate or deactivate the Soundbar's use of this data.

The Soundbar can store different data sets: The data of a calibration with subwoofer and the data of a calibration without subwoofer.

When the subwoofer connected to the Soundbar is deactivated or disconnected from the Soundbar, the Soundbar uses the data from a previous calibration without a subwoofer, if there is one.

To activate/deactivate the use of the room calibration data:

- ▷ Tap the **Audio** button in the **Settings** menu of the Smart Control app.  
A drop-down list appears.
- ▷ Tap the **Calibration** item in the drop-down list.
- ▷ In the **Calibrated Sound** section, activate or deactivate the use of room calibration data using the software switch.

If you are using "Dolby Virtualizer", the use of room calibration data is automatically deactivated and cannot be activated as long as "Dolby Virtualizer" is activated (> 60).

## Managing a subwoofer via the Sennheiser Smart Control app

### Connecting an AMBEO Sub wirelessly to the Soundbar via the Sennheiser Smart Control app

If an AMBEO Sub is already connected wirelessly to the Soundbar, you can connect additional AMBEO Subs wirelessly to the Soundbar via the Smart Control app.

- ▷ Make sure that the Soundbar and the AMBEO Sub are connected to the power supply.
- ▷ Tap the **Audio** button or the **System** button in the **Settings** menu of the Smart Control app.  
A drop-down list appears.
- ▷ Tap the **Subwoofer** item in the drop-down list.
- ▷ Tap **Add a new subwoofer** and follow the instructions in the Smart Control app

### Deleting pairing settings of the connected AMBEO Subs via the Sennheiser Smart Control app

When the Soundbar connects wirelessly to an AMBEO Sub, the Soundbar stores the pairing settings of the AMBEO Sub. To disconnect the connected AMBEO Sub from the Soundbar, you have to delete the pairing settings of all connected AMBEO Subs. It is not possible to delete the pairing settings of only one AMBEO Sub.

- ▷ Tap the **Audio** button or the **System** button in the **Settings** menu of the Smart Control app.  
A drop-down list appears.
- ▷ Tap the **Subwoofer** item in the drop-down list.
- ▷ Tap **Remove all**.  
The pairing settings of all connected AMBEO Subs will be deleted and you can pair the AMBEO Subs again if needed.

### Deactivating/activating subwoofers via the Sennheiser Smart Control app

Using the Smart Control app, you can deactivate all connected subwoofers so that no subwoofer is used during audio playback without having to disconnect the subwoofers from the Soundbar. It is not possible to deactivate only one subwoofer.

To deactivate the connected subwoofers:

- ▷ Tap the **Audio** button or the **System** button in the **Settings** menu of the Smart Control app.  
A drop-down list appears.
- ▷ Tap the **Subwoofer** item in the drop-down list.  
The **Subwoofer** menu opens.
- ▷ Tap the software switch next to **Subwoofer**.  
All connected subwoofers are deactivated.

To activate the connected subwoofers again:

- ▷ In the **Subwoofer** menu of the Smart Control app, tap the grayed-out software switch next to **Subwoofer**.  
All connected subwoofers are activated.

### Adjusting the volume of the AMBEO Sub

- ▷ Tap the **Audio** button or the **System** button in the **Settings** menu of the Smart Control app.  
A drop-down list appears.
- ▷ Tap the **Subwoofer** item in the drop-down list.  
The **Subwoofer** menu opens.
- ▷ Move the slider in the **Volume** section to reduce or increase the volume of the AMBEO Sub.

### Starting the room calibration with a subwoofer

After you have newly connected a subwoofer to the Soundbar, you have to perform a room calibration.

If you want to start the room calibration, you have the following options:

- Tap the **Start** button in the **System Calibration** area of the start screen of the Sennheiser Smart Control app (> 42).
- Press the Volume **+** and Volume **-** buttons on the Soundbar (> 42).
- Tap the **Start calibration** button in the **Calibration** menu.
- Tap the **Calibrate now** button in the **Subwoofer** menu.

Before calibrating, make sure that

- the Soundbar is connected to the power supply system and switched on (> 38),
- the subwoofer is connected to the power supply system and switched on (> 39),
- the microphones of the Soundbar are not muted (> 48) and
- it is quiet in the room where you are calibrating the Soundbar and the subwoofer.

To start the room calibration via the **Subwoofer** menu:

- ▷ Tap the **Audio** button or the **System** button in the **Settings** menu of the Smart Control app.  
A drop-down list appears.
- ▷ Tap the **Subwoofer** item in the drop-down list.  
The **Subwoofer** menu opens.  
If calibration is required, the **Calibrate now** button appears.
- ▷ Tap the **Calibrate now** button to start the room calibration.
- ▷ Follow the instructions in the Smart Control app.

To start the room calibration via the **Calibration** menu:

- ▷ Tap the **Calibration** button in the **Settings** menu of the Smart Control app.  
A drop-down list appears.
- ▷ Tap the **Calibration** item in the drop-down list.  
The **Calibration** menu opens.
- ▷ Tap the **Start calibration** button to start the room calibration.
- ▷ Follow the instructions in the Smart Control app.

## Adjusting the settings of the audio codec

If one of the following codecs is active via an input source, you can adjust the codec settings in the Sennheiser Smart Control app:

- Dolby
- DTS
- MPEG-H

### Setting options for Dolby codecs

Parameters	Meaning
Loudness Management	If you activate “Loudness Management” via the software switch, the volume of background noise/background music is reduced to make dialog tracks more audible.
Dynamic Range Control	Compress the dynamics of the audio signal to compensate for differences between quiet and loud passages. <ul style="list-style-type: none"> <li>• OFF: The audio signal is not compressed.</li> <li>• High: The audio signal is strongly compressed.</li> <li>• AUTO: The audio signal is compressed automatically. Changes in volume are noticeable during playback.</li> </ul>
Dolby Virtualizer	Activate “Dolby Virtualizer” via the software switch to play back Dolby audio content unchanged. If you activate “Dolby Virtualizer”, you cannot use the following settings and functions: <ul style="list-style-type: none"> <li>• Sound profiles</li> <li>• AMBEO</li> <li>• Equalizer</li> <li>• Room calibration data (as long as a “Dolby Virtualizer” is activated, the data obtained during room calibration will not be used during Dolby Audio content playback).</li> </ul>

### Setting options for DTS codecs

Parameters	Meaning
Neural:X Disabled	Use the software switch to activate upmixing of DTS audio content to create an immersive surround experience, even when only a stereo signal is present at the input source.
Dynamic Range Control	Compress the dynamics of the audio signal to compensate for differences between quiet and loud passages. To do so, move the slider between “OFF” and “100%”. <ul style="list-style-type: none"> <li>• OFF: The audio signal is not compressed.</li> <li>• 100 %: Loud passages become quieter, quiet passages become louder.</li> </ul>
Dialog Control	Move the slider to reduce the volume of background noise/background music and make dialog tracks more audible.



### Setting options for MPEG-H codecs

Parameters	Meaning
Dialog Normalization	If you activate “Dialog Normalization” via the software switch, the volume of background noise/background music is reduced to make dialog tracks more audible.
Dynamic Range Control	Adjust the dynamics of the audio signal to compensate for differences between quiet and loud passages or to boost the volume of loud passages. To do so, move the slider between “Compression”, “OFF” and “Boosting”. <ul style="list-style-type: none"> <li>• Compression: Loud passages become quieter, quiet passages become louder.</li> <li>• OFF: The audio signal is not compressed.</li> <li>• Boosting: The volume of loud passages is boosted.</li> </ul>

### Adjusting the codec settings

- ▷ Tap the **Codec** button in the **Settings** menu of the Smart Control app.  
The active codec is displayed.
- ▷ Tap the name of the codec.  
A submenu for the active codec opens.
- ▷ Adjust the desired settings for the active codec.

## Using streaming services

You can activate audio playback via streaming services in the Sennheiser Smart Control app. To be able to use a streaming service, you have to have an account with the streaming service.

The following services are already available upon delivery:

- Tidal Connect
- Spotify Connect
- Chromecast built-in
- Works with Apple AirPlay

### Configuring a streaming service

- ▷ Tap the **Services** button in the **Settings** menu of the Smart Control app.  
A drop-down list appears.
- ▷ Tap the desired service and configure it as a streaming source.

### Adjusting the settings for streaming services

You can adjust additional settings for your streaming services in the Smart Control app.

- ▷ Tap the **Services** button in the **Settings** menu of the Smart Control app.  
A drop-down list appears.
- ▷ Select **Add services** from the drop-down list.  
The **Set up your services** menu opens.
- ▷ Adjust the desired settings.

## Activating and using voice assistants

You can optionally connect the Soundbar to the following voice assistants:

- Alexa (built-in)
- OK Google (works with)

To do so, you have to have an account with the respective voice assistant.



The voice assistants are deactivated upon delivery. To use the voice assistants, you have to first activate them in the Sennheiser Smart Control app.

### Activating a voice assistant

- ▷ Tap the **Services** button in the **Settings** menu of the Smart Control app.  
A drop-down list appears.
- ▷ Select **Add services** from the drop-down list.  
The **Set up your services** menu opens.
- ▷ In the **Setup** section, activate the desired voice assistant.

### Notes on the use of voice assistants

To be able to use a voice assistant with the Soundbar, make sure that the Soundbar's microphones are not muted (> 48).

Note that activating the Amazon Alexa voice assistant changes the function of the Multi-purpose  button on the Soundbar and the remote control (> 44). When Alexa is activated, pressing the Multi-purpose  button will trigger Alexa or cancel a command to Alexa.

When a voice assistant is triggered by an activation word (e.g. "Okay Google" or "Alexa") or, in the case of Amazon Alexa, by pressing the Multi-purpose  button and processes a command, the volume of the audio playback is briefly reduced. This ensures that the voice assistant can hear your commands.

## Controlling audio playback

Audio playback is only possible after an input source has been selected.

If you want to control audio playback, you have the following options:

- The context-sensitive buttons in the playback area of the Sennheiser Smart Control app
- The Multi-purpose  button on the Soundbar or the remote control (> 44)

## Ending audio playback

If you want to end audio playback, you have the following options:

- End audio playback using the context-sensitive buttons in the playback area of the Sennheiser Smart Control app.
- Briefly press the Multi-purpose  button on the Soundbar or the remote control (> 44).
- End audio playback at the input source (e.g. your TV).

 If there is no audio playback for at least 10 seconds, the Soundbar automatically switches to ECO mode.

## Selecting a sound profile

The Soundbar comes with various preset sound profiles upon delivery. The sound profiles are optimized for playing back different audio contents (e.g. music, news broadcasts, movies).

The following sound profiles are available:

- **Adaptive**  
The settings of the sound profile **Adaptive** are changed automatically during playback. In this way, the sound profile continuously adapts to the content being played back.
- **Music**  
The sound profile **Music** is optimized for the playback of music.
- **Movie**  
The sound profile **Movie** is optimized for the playback of movies.
- **News**  
The sound profile **News** is optimized for the playback of news broadcasts.
- **Neutral**  
The sound profile **Neutral** reproduces the sound of the input source unchanged.
- **Sports**  
The sound profile **Sports** is optimized for the playback of sports broadcasts.

Once you have activated a sound profile for an input source, the sound profile for this input source is saved until you activate another sound profile for this input source.

Using the Soundbar's remote control and the Sennheiser Smart Control app, you can also switch between the different sound profiles during audio playback.

### Activating a sound profile

To activate a sound profile via the Soundbar's remote control:

- ▷ Press the sound profile button of the desired sound profile.

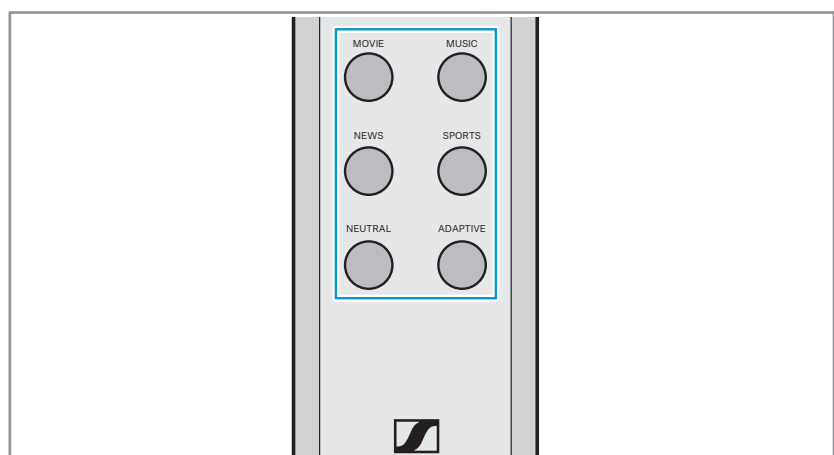

To activate a sound profile using the Sennheiser Smart Control app:

- ▷ Open the Smart Control app.
- ▷ Tap the desired sound profile.  
The active sound profile is marked with a check mark.

### Deactivating a sound profile

To deactivate a sound profile via the Soundbar's remote control:

- ▷ Press the sound profile button of the desired sound profile.

To deactivate a sound profile via the Sennheiser Smart Control app:

- ▷ Tap the check mark with which the active sound profile is marked. The sound profile is deactivated. The check mark is removed.

### Editing a sound profile

You can edit the sound settings of the sound profiles to suit your needs.

- ▷ Activate the desired sound profile. The **Edit** button appears.

- ▷ Tap the **Edit** button.

The settings menu of the sound profile opens.

You can adjust the following settings in the settings menu of the sound profile:

- **AMBEO 3D Sound**  
When AMBEO is activated (> 66), you can adjust the intensity of the AMBEO 3D surround effect by selecting one of 3 modes:
  - **Light**  
light AMBEO spatial sound
  - **Regular**  
normal AMBEO spatial sound
  - **Boost**  
maximum AMBEO spatial sound
- **Foundation**  
Adjust the bass of the frequency range.
- **Low-Mid**  
Adjust the lower midrange.
- **Clarity** and **Brilliance**  
Adjust the treble of the frequency range.
- **Preset reset**  
Reset the sound profile to the factory default settings.

## Activating/deactivating AMBEO

To activate AMBEO:

- ▷ Open the Sennheiser Smart Control app.
- ▷ In the **AMBEO** section, tap the **On** button.  
AMBEO is activated and the button is highlighted in blue.

To deactivate AMBEO:

- ▷ In the **AMBEO** section, tap the **Off** button.  
AMBEO is deactivated and the blue highlighting of the button is removed.

You can further adjust the AMBEO effect for each sound profile (> 64).

## Activating/deactivating the night mode “Night”

In night mode, the Soundbar does not reproduce any deep bass.

The night mode “Night” can be used in addition to a sound profile. The night mode is globally applied to all sound profiles.

When the night mode “Night” is activated, the LED status bar of the Soundbar lights up purple.

### Activating/deactivating the night mode “Night” via the remote control

- ▷ Press the **Night** button on the remote control.

### Activating/deactivating the night mode “Night” via the Sennheiser Smart Control app

- ▷ In the Smart Control app, tap the software switch next to the display **Night mode**.  
When the night mode “Night” is activated, the software switch is highlighted in blue.

## Activating/deactivating the voice mode “Voice”

In voice mode, speech is output particularly clearly and distinctly. The voice mode “Voice” can be used in addition to a sound profile. The voice mode is globally applied to all sound profiles.

When the voice mode “Voice” is activated, the LED status bar of the Soundbar lights up light blue.

### Activating/deactivating the voice mode “Voice” via the remote control

- ▷ Press the **Voice** button on the remote control.

### Activating/deactivating the voice mode “Voice” via the Sennheiser Smart Control app

- ▷ In the Smart Control app, tap the software switch next to the display **Voice Enhancement**.  
When the voice mode “Voice” is activated, the software switch is highlighted in blue.

# Care and maintenance of the Soundbar

## Cleaning the Soundbar

---

### ATTENTION

Liquids can damage the electronics of the product!

Liquids entering the housing of the product can cause a short-circuit and damage the electronics.

- ▷ Keep all liquids far away from the product.
  - ▷ Do not use any solvents or cleansing agents.
- 

- ▷ Clean the product only with a soft, dry cloth.  
The fabric of the Soundbar cannot be removed.
- ▷ Clean the fabric with a soft brush.

## Replacing the battery of the remote control

If the range of the remote control decreases, you have to replace the battery.



### CAUTION

#### Danger of accidents!

Misuse or swallowing of batteries can cause injuries and health problems.

- ▷ Observe the safety instructions for lithium batteries (> 4).
  - ▷ Keep batteries away from children.
- 

- ▷ Use a suitable object (e.g. a coin) to open the battery compartment cover by turning one turn counter-clockwise.
- ▷ Remove the used battery. In order to protect the environment, dispose of used batteries at special collection points or return them to your specialist dealer.
- ▷ Insert the new battery (type CR2032, 3 V) into the battery compartment. Observe correct polarity when inserting the battery.
- ▷ Close the battery compartment cover by turning one turn clockwise.



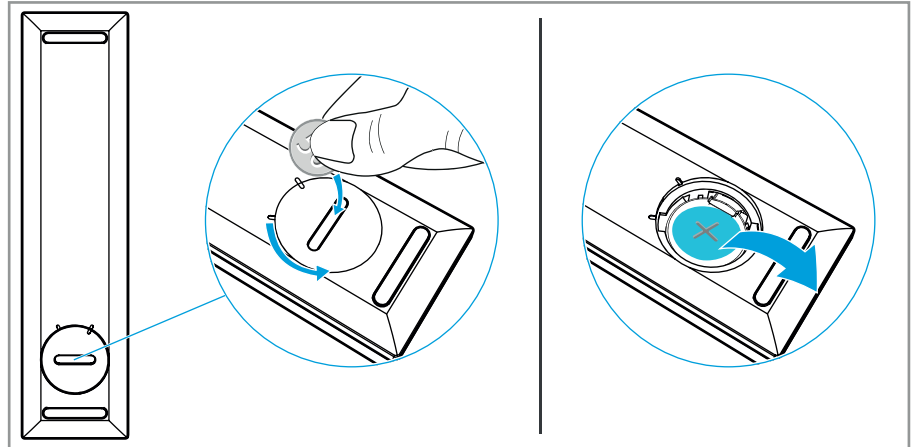

## Installing firmware updates

Firmware updates are available free of charge and serve to enhance product improvement and also function extension. Sonova Consumer Hearing recommends to always install the latest firmware version to ensure the best performance of your product.

You can update the firmware of the Soundbar and the AMBEO Sub(s) using a USB flash drive or via the Internet using the Sennheiser Smart Control app.

### Update via the Sennheiser Smart Control app

To update the firmware via the Smart Control app, the Soundbar has to be connected to the Internet via WiFi or Ethernet (> 53).

If you want to update the firmware, you have the following options:

- Tap the **Update** button in the start screen of the Smart Control app (only visible if an update is available).
- Tap the **Update** button in the “Firmware” menu.

### Update via a USB flash drive

Required USB flash drive:

- Memory size: 1 GB
- USB-A connection
- File system: FAT

1. Download the update file with the file name “image.swu” from the website [www.sennheiser-hearing.com/download](http://www.sennheiser-hearing.com/download) and save it on a USB flash drive.

Do not change the file name!

▷ Switch the Soundbar on.

2. Connect the USB flash drive to the USB socket on the Soundbar.

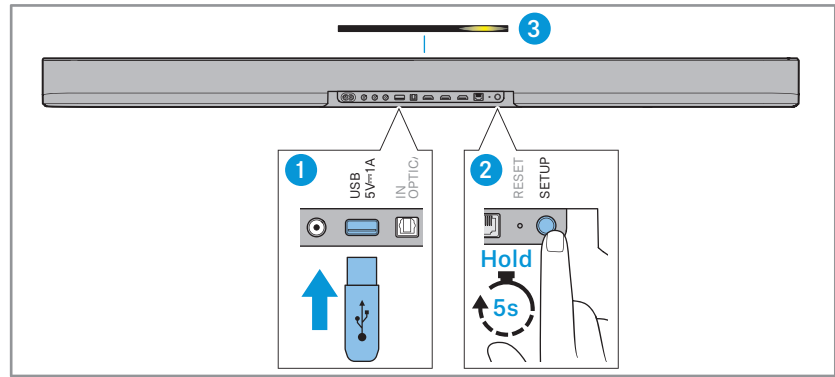

3. Press the Setup button for 5 seconds.  
The update starts and the LED status bar pulses yellow.  
The Soundbar restarts several times during the update. The process can take up to 8 minutes.

## Resetting the Soundbar

- ▷ Switch the Soundbar on.

If you want to reset the Soundbar, you have the following options:

- Reset of all Soundbar settings to the factory default settings
- Reset of all network connections
- Reset of all room calibration data

### Resetting the Soundbar to the factory default settings

If you reset the Soundbar to factory default settings, the network settings and the room calibration data will also be reset.

To reset the Soundbar to the factory default settings without the Sennheiser Smart Control app:

- ▷ Insert e.g. a paper clip into the **RESET** recess on the rear of the Soundbar and press the paper clip for 2 seconds.

To reset the Soundbar to the factory default settings via the Sennheiser Smart Control app:

- ▷ Tap the **System** button in the **Settings** menu of the Smart Control app.  
A drop-down list appears.
- ▷ Select **Reset** from the drop-down list.
- ▷ In the **Reset all settings** area, tap the **Reset** button.

During the reset, the LED status bar displays a red and white sequence.

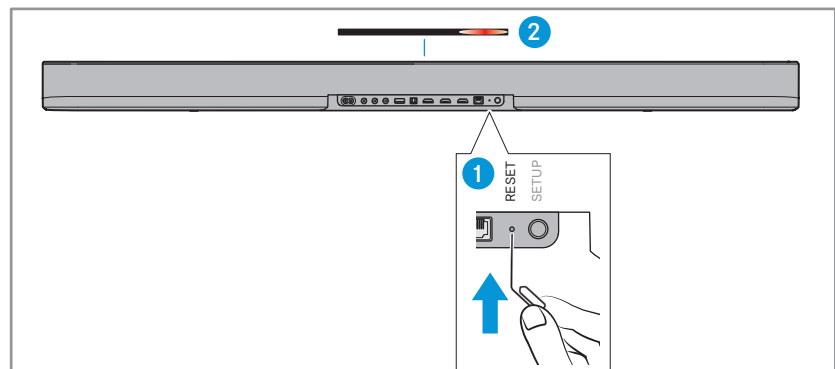

### Resetting all network connections

You can only reset the network connections via the Sennheiser Smart Control app.

- ▷ Tap the **System** button in the **Settings** menu of the Smart Control app.  
A drop-down list appears.
- ▷ Select **Reset** from the drop-down list.
- ▷ In the **Reset network settings** area, tap the **Reset** button.

### Resetting all room calibration data

You can only reset the room calibration data via the Sennheiser Smart Control app.

- ▷ Tap the **System** button in the **Settings** menu of the Smart Control app.  
A drop-down list appears.
- ▷ Select **Reset** from the drop-down list.
- ▷ In the **Reset system calibration** area, tap the **Reset** button.

## FAQ/If a problem occurs ...

If a problem has occurred, proceed in the following order until the problem is solved and you can use the AMBEO Soundbar system again:

1. Disconnect the Soundbar and/or the subwoofer from the power supply system. Wait for at least 10 seconds before connecting the device to the power supply system again (> 38).
2. Connect the Soundbar and/or the subwoofer to the Sennheiser Smart Control app to install the latest firmware (> 40).
3. Check the list of frequently asked questions to see if there is a solution to the problem (> 72).
4. Reset the Soundbar and/or the subwoofer to the factory default settings (> 70).
5. Contact your Sonova Consumer Hearing partner to solve the problem (> 72).

### Current list of frequently asked questions (FAQ)

Visit the AMBEO Soundbar system SB02 product pages at

[www.sennheiser-hearing.com/ambeo-soundbar-plus/](http://www.sennheiser-hearing.com/ambeo-soundbar-plus/)

or

[www.sennheiser-hearing.com/ambeo-sub/](http://www.sennheiser-hearing.com/ambeo-sub/)

There you will find a current list of frequently asked questions (FAQ) and suggested solutions.

### Your question has not been answered or the problem persists?

If a problem occurs that is not listed in the FAQ section or if the problem cannot be solved with the proposed solutions, please contact your Sonova Consumer Hearing partner for assistance.

To find a partner in your country, search at [www.sennheiser-hearing.com/service-support](http://www.sennheiser-hearing.com/service-support).

# Specifications

## AMBEO Soundbar | Plus Model SB02M

Number of channels	7.1.4
Amplifier	class D
Total audio power	400 W (RMS)
Total number of speakers	9
Woofers	quantity 2 (top: right and left) Ø 10 cm/4 inches cellulose cone drivers
Full-range speakers	quantity 7 (lateral: right and left, top: right and left, front: right, center and left) Ø 5 cm/2 inches aluminum cone drivers
Frequency response	38 Hz to 20 kHz (-3 dB)
Audio processor	quad-core SOC processor, 1.8 GHz
Microphones for room calibration and voice assistants	4 built-in high-precision far-field microphones
Displays	LED status bar AMBEO display Active Codec display Microphones Off/WiFi Status display
Power plug	county-specific
Voltage range	100 – 240 V~ 50/60 Hz
Power consumption	max. 2 A
Standby power consumption	standby: 1.9 W standby w/o network connection: < 0.5 W
Temperature range	operation: 0 °C to +40 °C/+32 °F to +104 °F storage: -20 °C to +70 °C/-13 °F to +158 °F
Relative humidity (non condensing)	operation/storage: 10 % to 90 %
Dimensions (W x H x D)	approx. 105.1 x 7.7 x 12.1 cm incl. feet approx. 105.1 x 7.5 x 12.1 cm w/o feet
Weight	approx. 6.3 kg
Magnetic field strength	23.5 mT

**Inputs/outputs**  
**AMBEO Soundbar | Plus**

HDMI TV (e)ARC	default: HDMI eARC 2.1 control: CEC encryption: HDCP 1.4 Power supply for accessories (external devices): 5 V $\overline{\text{DC}}$ , 1 A
HDMI 1 IN HDMI 2 IN	default: HDMI 2.0a encryption: HDCP 2.2 control: CEC video formats: up to 4K (60 Hz), Full HD, MHL 2.1 HDR formats: Dolby Vision Pass-Through
OPTICAL IN	S/PDIF Supported sampling rates: up to 192 kHz
AUX IN L and R	stereo RCA sockets
USB	USB socket (type A), power supply for accessories (external devices): 5 V $\overline{\text{DC}}$ , 1 A; service socket for updates
ETHERNET	RJ-45 socket, 100/10 MBit
Subwoofer SW Pre-OUT	mono RCA, max. 2 V

**WiFi**  
**AMBEO Soundbar SB02**

Standard	IEEE 802.11 a/b/g/n/ac/ax
Transmission system	2 x 2 MIMO
Transmission frequency (country-specific)	2,400 MHz to 2,483.5 MHz 5170 MHz to 5835 MHz
Modulation 2.4 GHz band	CCK, DQPSK, DBPSK für DSSS 64QAM, 16QAM, QPSK, BPSK for OFDM
Modulation 5 GHz band	1024-QAM, 256-QAM, 64QAM, 16QAM, QPSK, BPSK
Output power	100 mW (max)

**Bluetooth**  
**AMBEO Soundbar SB02**

Version	5.0 Classic, BLE for AMBEO Sub connection: 5.2, Bluetooth Low Energy
Transmission frequency	2,400 MHz to 2,483.5 MHz
Modulation	GFSK, $\pi/4$ DQPSK, 8DPSK
Profiles	A2DP, AVRCP, GATT
Output power	10 mW (max)
Codec	AAC, SBC for AMBEO Sub connection: LC3

Network streaming, services and control  
 AMBEO Soundbar SB02

Network	Ethernet WiFi
Services	Chromecast built-in AirPlay 2 Spotify Connect Tidal Connect uPnP
Voice assistants (depending on region)	Alexa built-in Works with OK Google
Control/Setup	Sennheiser Smart Control app (available for iOS and Android) Web browser (accessible via hotspot ("AMBEO Soundbar [serial number]") and address: <a href="http://192.168.255.249/">http://192.168.255.249/</a> or (with established WiFi connection): <a href="http://ambeo">http://ambeo</a> )

Playable audio formats for network streaming  
 AMBEO Soundbar SB02

Audio format/Codec	File extension
DSD	yes
MP3	yes
AAC/HE-AAC	yes
LPCM	yes
FLAC	yes
AIFF	yes
ALAC	yes
Vorbis	yes
Dolby Atmos Music	yes
Sony 360 Reality Audio	yes

Supported audio/surround formats  
**AMBEO Soundbar SB02**

Audio format/Codec	HDMI	OPTICAL
LPCM 2 Channel	yes	yes
LPCM 5.1 Channel	yes	yes
LPCM 7.1 Channel	yes	yes
Dolby Digital	yes	yes
Dolby Digital Plus	yes	yes
Dolby True HD	yes	-
Dolby Atmos - Dolby TrueHD	yes	-
Dolby Atmos - Dolby Digital Plus	yes	yes
DTS	yes	yes
DTS-ES Discrete 6.1,	yes	yes
DTS-ES Matrix 6.1	yes	-
DTS 96/24	yes	yes
DTS-HD High Resolution Audio	yes	-
DTS-HD Master Audion	yes	-
DTS-HD LBR	yes	-
DTS:X	yes	-
MPEG-H (Fraunhofer)	yes	yes
Dolby Atmos Music	yes	-
Sony 360 Reality Audio	yes	yes

Remote control  
**Model SB02-RC**

Transmission	infra-red
Range	approx. 8 m
Power supply	coin cell, type CR2032, 3 V

AMBEO Sub  
**Model SW02**

Amplifier	class D
Total audio power	350 W (RMS)
Total number of speakers	1
Woofers	Ø 20 cm/8 inches long-throw cellulose cone driver
Frequency response	27 Hz to 80 Hz (-3 dB)
Power plug	country-specific
Voltage range	100 – 240 V~ 50/60 Hz
Power consumption	max. 2.5 A
Standby power consumption	wireless operation: < 1.9 W wired operation: < 0.4 W



## Specifications

Temperature range	operation: 0 °C to +40 °C/+32 °F to +104 °F storage: -20 °C to +70 °C/-13 °F to +158 °F
Relative humidity (non condensing)	operation/storage: 10 % to 90 %
Dimensions (W x H x D)	approx. 27.7 x 36.9 x 27.4 cm
Weight	approx. 8.2 kg
Magnetic field strength	2 mT
Bluetooth version	5.2, Bluetooth Low Energy
Transmission frequency	2,400 MHz to 2,483.5 MHz
Modulation	GFSK
Output power	10 mW (max)
Codec	LC3
Range	up to 10 m

# Manufacturer declarations

## Warranty

Sonova Consumer Hearing GmbH gives a warranty of 24 months on this product.

For the current warranty conditions, please visit our website at [www.sennheiser-hearing.com/warranty](http://www.sennheiser-hearing.com/warranty) or contact your Sonova Consumer Hearing partner.

## In compliance with the following requirements

### EU declaration of conformity



- RoHS Directive (2011/65/EU)
- ErP Directive (2009/125/EC)

Hereby, Sonova Consumer Hearing GmbH declares that the radio equipment type SB02M, SW02 is in compliance with the Radio Equipment Directive (2014/53/EU).

The full text of the EU declaration of conformity is available at the following Internet address: [www.sennheiser-hearing.com/download](http://www.sennheiser-hearing.com/download).

### UK declaration of conformity



- RoHS Regulations (2012)
- The Ecodesign for Energy-Related Products and Energy Information (Amendment) (EU Exit) Regulations (2019)
- Radio Equipment Regulations (2017)

### Notes on disposal



- EU: Battery Directive (2006/66/EC & 2013/56/EU)
- EU: WEEE Directive (2012/19/EU)
- UK: Battery Regulations (2015)
- UK: WEEE Regulations (2013)

The symbol of the crossed-out wheeled bin on the product, the battery/rechargeable battery (if applicable) and/or the packaging indicates that these products must not be disposed of with normal household waste, but must be disposed of separately at the end of their operational lifetime. For packaging disposal, observe the legal regulations on waste segregation applicable in your country. Improper disposal of packaging materials can harm your health and the environment.

The separate collection of waste electrical and electronic equipment, batteries/rechargeable batteries (if applicable) and packagings is used to promote the reuse and recycling and to prevent negative effects on your health and the environment, e.g. caused by potentially hazardous substances contained in these products. Recycle electrical and electronic equipment and batteries/rechargeable batteries at the end of their operational lifetime in order to make contained recyclable materials usable and to avoid littering the environment.

If batteries/rechargeable batteries can be removed without damaging them, you are obliged to dispose of them separately (for the safe removal of batteries/rechargeable batteries, see the instruction manual of the product). Handle lithium-containing batteries/rechargeable batteries with special care, as they pose particular risks, such as the risk of fire and/or the risk of ingestion in the case of coin batteries. Reduce the generation of battery waste as much as possible by using longer-life batteries or rechargeable batteries.

Further information on the recycling of these products can be obtained from your municipal administration, from the municipal collection points, or from your Sonova Consumer Hearing partner. You can also return electrical or electronic equipment to distributors who have a take-back obligation. Herewith you make an important contribution to the protection of the environment and public health.

### Trademarks

Apple, iPhone, the Apple logo and Siri are trademarks of Apple Inc., registered in the U.S. and other countries. App Store is a service mark of Apple Inc. The trademark “iPhone” is used in Japan with a license from Aiphone K.K.

Google Play and the Google Play logo are trademarks of Google LLC. The Bluetooth® word mark and logos are registered trademarks owned by Bluetooth SIG, Inc. and any use of such marks by Sonova Consumer Hearing GmbH is under license.

Qualcomm aptX is a product of Qualcomm Technologies International, Ltd. Qualcomm is a trademark of Qualcomm Incorporated, registered in the United States and other countries, used with permission.

aptX is a trademark of Qualcomm Technologies International, Ltd., registered in the United States and other countries, used with permission.

Other product and company names mentioned in the user documentation may be the trademarks or registered trademarks of their respective holders.