

...UNCOVER, OPEN, REVEAL...



# APERIO

WARWICK ACOUSTICS 



The background of the image is a close-up, slightly blurred view of yellow acoustic foam. The foam consists of numerous elongated, curved segments arranged in a repeating pattern. Each segment has a fine, grid-like texture on its surface. The lighting is soft, highlighting the texture and color of the foam.

WARWICK<sup>TM</sup>  
ACOUSTICS





At Warwick Acoustics, we are single-minded in our mission;  
*to create remarkable listening experiences.*

Our ground-breaking audio systems will breathe fresh new life into the music that moves you. Whether it's through our multi-award-winning headphone systems or our world first in-car electrostatic systems, we offer a listening experience that's as immersive as it is intimate, as thrilling as it is authentic.

We believe in creating products that are designed from the ground up in order to deliver the best personal audio listening experience available to our customers.

Our team are pioneering perfectionists. The pursuit of excellence is our primary goal, and everything really does matter!

From custom built low noise power supplies to the highest grade cables and leather ear pads. *Passion, Transparency, Neutrality, Truthfulness* are all words close to our hearts....

**DESIGNED TO AMAZE**







# APERIO

WARWICK ACOUSTICS 

---

**APERIO** - from the Latin, meaning to *uncover, open, reveal*.

The model name for Warwick Acoustics' flagship, reference headphone system is a literal match for our design goal: *to reproduce and reveal all recorded audio content definitively, without alteration*.

The APERIO is designed for the demanding professional audio market, as a reference studio monitor headphone system for High-Resolution Audio production, mastering, mixing and recording applications. Moreover, the APERIO is designed to be equally capable in ultra-high-end home consumer applications.

The APERIO reference headphone system strives to deliver the highest level of audio performance achievable, by means of our proprietary planar electrostatic technology.

The APERIO utilises a highly-refined, evolutionary advancement of technology originally developed by Warwick Acoustics for its ground-breaking and multi-award-winning *Sonoma Model One Headphone System*.



# DESIGN PHILOSOPHY

---

Central to achieving our performance goal is the Design Philosophy behind the APERIO – a concept embodied in every product developed by Warwick Acoustics and the mantra of our design and development team, from initial concept through final production. To be truly revealing of all audio content without alteration requires the entire sound reproduction system, or every element in the signal path, to be accurate and free from all forms of distortion – in a word, completely “transparent”. The reproduction system cannot impose its own sonic character – or colourations of any kind – upon the audio content. All data, whether it be analogue or digital, must be reproduced unadulterated.

Warwick Acoustics espouses a “Complete System Design” approach for all of our products. Complete System Design entails development and engineering of every element in the signal path of the sound reproduction system, from the initial delivery of analogue or digital audio content (data) to the final sound at the listener’s ears. The APERIO represents the pinnacle of this design philosophy by eliminating compromise for every element of the system and employing extraordinary attention to detail. A “flagship” or “reference” product should inherently mean that no compromises in design or execution are acceptable and that all the details matter.

We believe a “Complete System Design” philosophy is necessary and required to achieve the highest level of audio performance and sound quality. This is analogous to a computer company controlling and optimising the hardware and OS software together, or to a premium automotive brand developing an ultra-high-performance sports car (“supercar” or “hypercar”). The highest levels of performance cannot be achieved with a “Hot Rod” approach of mixing and matching disparate components and technologies because they are not optimised to work together in a synergistic manner. Engineering of a complete and fully-optimised system will always outperform a combination of separately-engineered components at the highest levels. This Engineering philosophy is well-understood, accepted and applied in the computer, aerospace and automotive worlds. And we believe the same philosophy is valid for sound reproduction. The APERIO’s purpose is simply to reproduce audio content as pristinely and accurately as possible – without change or alteration. And this can only be achieved by means of a Complete System Design methodology.





WARWICK  
ACOUSTICS

APERIO

HP OUTPUT





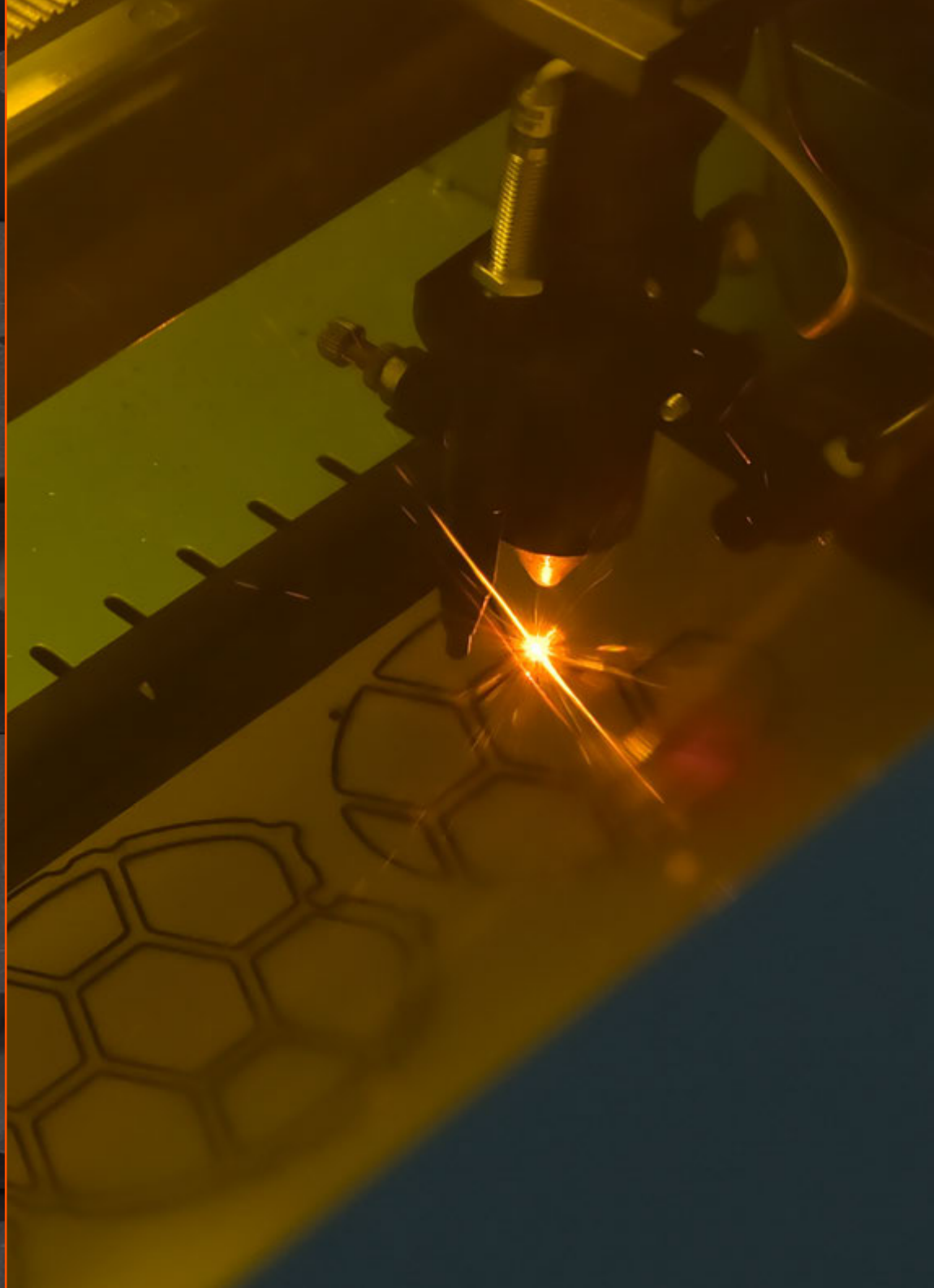
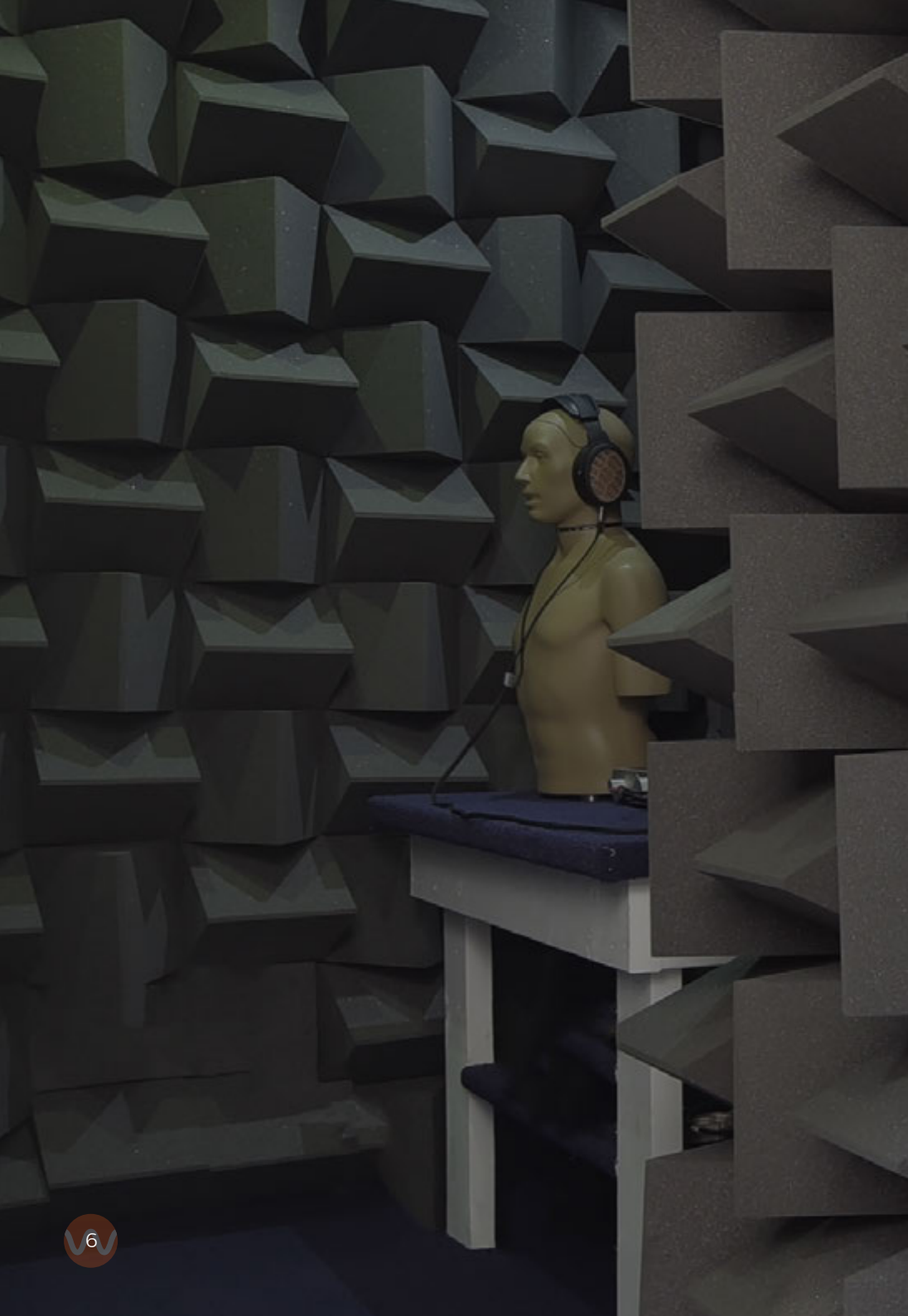



While the APERIO exhibits exceptional audio performance measurements – both electrical and acoustical, it was not designed to meet specific measurements or expressly to measure well. The performance measurements serve primarily to validate that relevant key metrics have been met and that no performance anomalies have obscured sound reproduction. We believe measurements do not fully characterise a product's sound quality; however, we feel they are a necessary and crucial part of the design process, and provide confirmation that units are performing properly after assembly. Warwick Acoustics is one of the very few manufacturers to provide individual measurements of every system built to end users.

A final element of our Design Philosophy for the APERIO should be apparent from its appearance. This is a product that employs the finest materials available in a carefully-assembled system of the highest build quality possible. Warwick Acoustics believes in and adheres to a "Form Follows Function" industrial design principle (per the American architect Louis Henry Sullivan), epitomised by the APERIO.

We do not design our products to appear purposely "exotic" or over-stylised, like much of the "audio jewellery" that inundates the high end consumer audio market. Instead we aspire for our products to look and feel beautiful in an authentic, functional way, with an innate, timeless element of "quality" in every piece.



# APPLICATIONS / FEATURES

---

The APERIO is designed for demanding applications that require ultra-high resolution and higher output levels. The APERIO has been optimised for resolving the most minute, low-level details present on any form of audio media. These capabilities must be achieved without inducing distortion artifacts and other anomalies, such as “listener fatigue”. Sound reproduction quality and audio performance should be identical at all listening levels.

The APERIO features a wide range of inputs, including balanced and unbalanced analogue, AES3 (AES/EBU), S/PDIF Coaxial, USB and Ethernet (LAN). The APERIO is unique in being a fully networkable product that exceeds typical DLNA limitations and allows digital audio reproduction of native or DoP 256 fs DSD and higher sample rate PCM formats to 384 kHz. Within the APERIO all audio signals are kept in their native domain and format: analogue always remains analogue; DSD stays DSD until its final conversion to analogue; PCM sample rates are never converted. The signal path is pure, as direct as possible and unadulterated.

The APERIO also features an exceptional Line Output section for driving other electronics and sound reproduction components that include outboard amplifiers and loudspeakers. Balanced and unbalanced outputs are capable of driving very long cables to the highest levels with prodigious current delivery. For studio applications, downstream components connected by 150-meter balanced cables can be driven to 15 dBu without distortion. The Line Output feature, in conjunction with an uncompromised Digital-to-Analogue Converter (DAC), preamplifier functionality and outstanding audio fidelity, enable the APERIO to perform optimally as the central hub of a state-of-the-art, two-channel studio monitoring system or ultra-high-end home audio system.





The APERIO indicates its output level in precise 0.1dB increments via a front panel full-colour, high-resolution display. This display also alerts the user if any faults such as output clipping, over-heating or disconnected cables are detected.

The APERIO's firmware is updatable via its USB input, using a simple APP for any Windows / MAC / Linux-based host. This feature allows users to keep the APERIO current and up-to-date over its full lifetime.

The complete APERIO system (headphone, electronics and accessories) is packaged in an exceptionally durable travel case, formed of heavy-duty Polypropylene. This case is watertight, crushproof, and dustproof, and features an automatic pressure equalisation valve that balances interior pressure, keeping water out.

The case also features a retractable extension handle, stainless steel hardware and four polyurethane wheels. This rugged case provides complete protection of the entire APERIO system and enables it to be conveniently transportable.





# TRANSDUCER TECHNOLOGY OVERVIEW

---

The single most crucial component of any headphone system is the transducer. The ultimate performance of the complete sound reproduction system will be determined and limited by the acoustical performance and fidelity of the transducer.

The APERIO utilises a new Balanced-Drive HPEL Transducer (BD-HPEL) – a symmetrically-driven variant of Warwick Acoustics' High Precision Electrostatic Laminate (HPEL) transducer, originally developed for the Sonoma Model One headphone system. The BD-HPEL was developed specifically for applications that demand the highest level of audio resolution and greater output capability.

The BD-HPEL requires symmetrical, high voltage drive signals to generate a differential, electrostatic force that moves the diaphragm. The BD-HPEL has twice the excursion capability, greater linearity and lower distortion than Warwick Acoustics' first generation HPEL.

This next-generation HPEL transducer is built in the United Kingdom, at Warwick Acoustics' state-of-the-art R&D facility. The BD-HPEL is manufactured under strict laboratory conditions using proprietary, semi-automated, cell-based production techniques. We control all aspects of sourcing, production, testing and quality assurance. Every transducer produced is tested in our lab, graded and matched within 0.5 dB to a complementary unit to form a matched-pair. Only the best-performing matched-pairs of BD-HPELs are installed in APERIO headphones.

The core technology of our BD-HPEL has been refined over several years to be impervious to environmental changes such as temperature and humidity variation, stable in performance and sound quality over time (even after years of daily use), and extremely durable. These characteristics have been achieved because of the simplicity and robustness of the design, utilisation of only the finest materials available and Warwick's proprietary manufacturing processes.

The BD-HPEL retains Warwick Acoustics' patented cellular structure, which acts to significantly reduce and distribute resonant phenomena, and extends bandwidth to over 60 kHz. Subdivided cells act as smaller, phase-aligned planar sources, whose parallel-driven outputs combine acoustically to form a cohesive planar wave front.

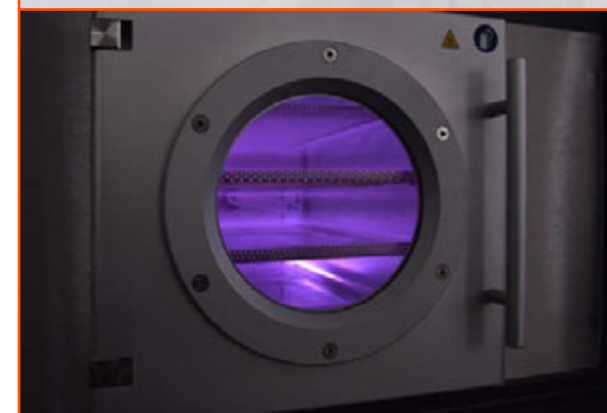
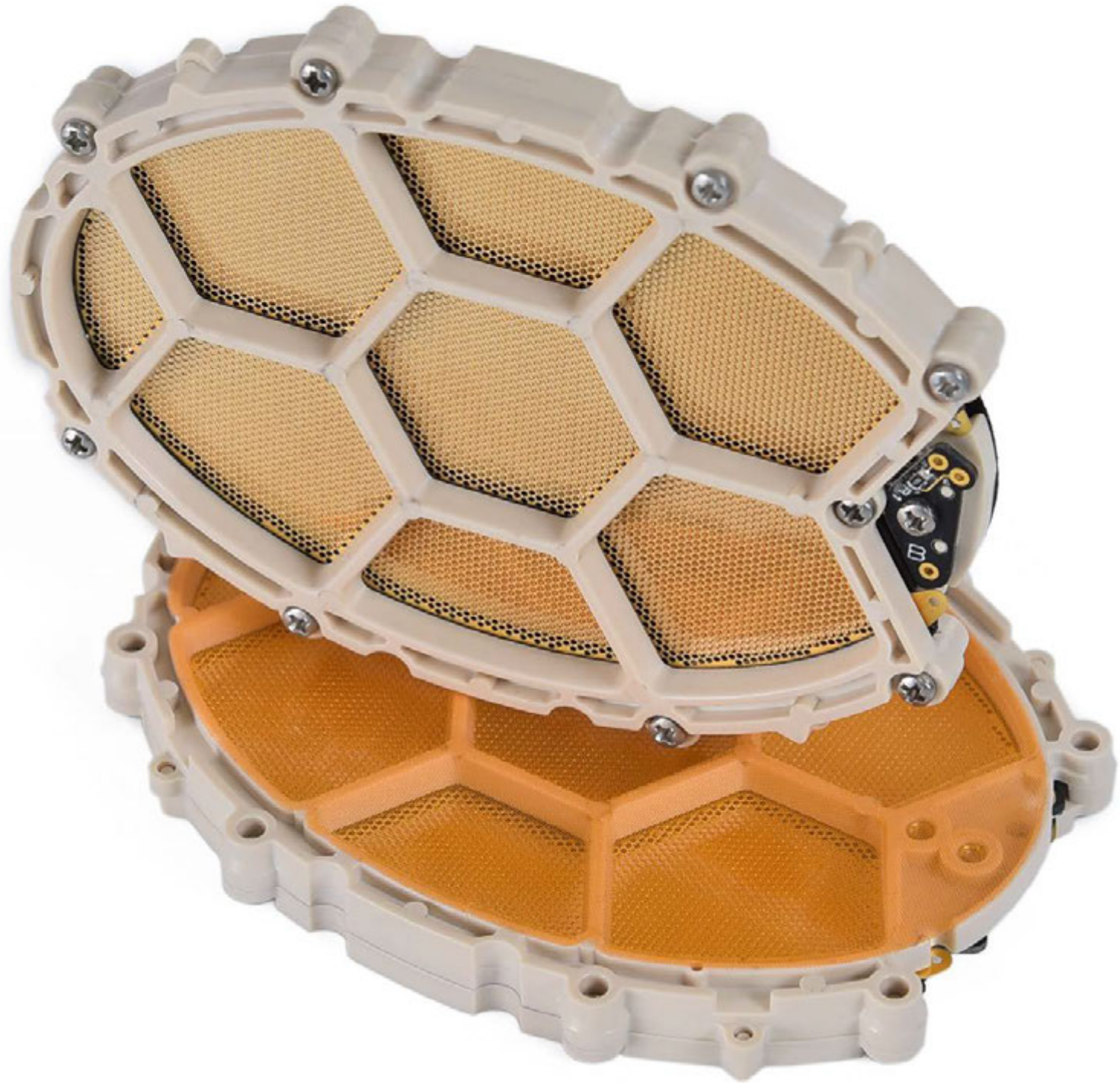

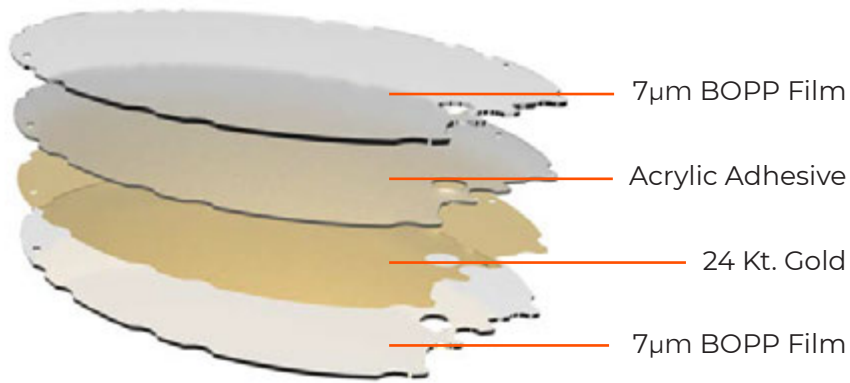

**Composite Multilayer Film Diaphragm**

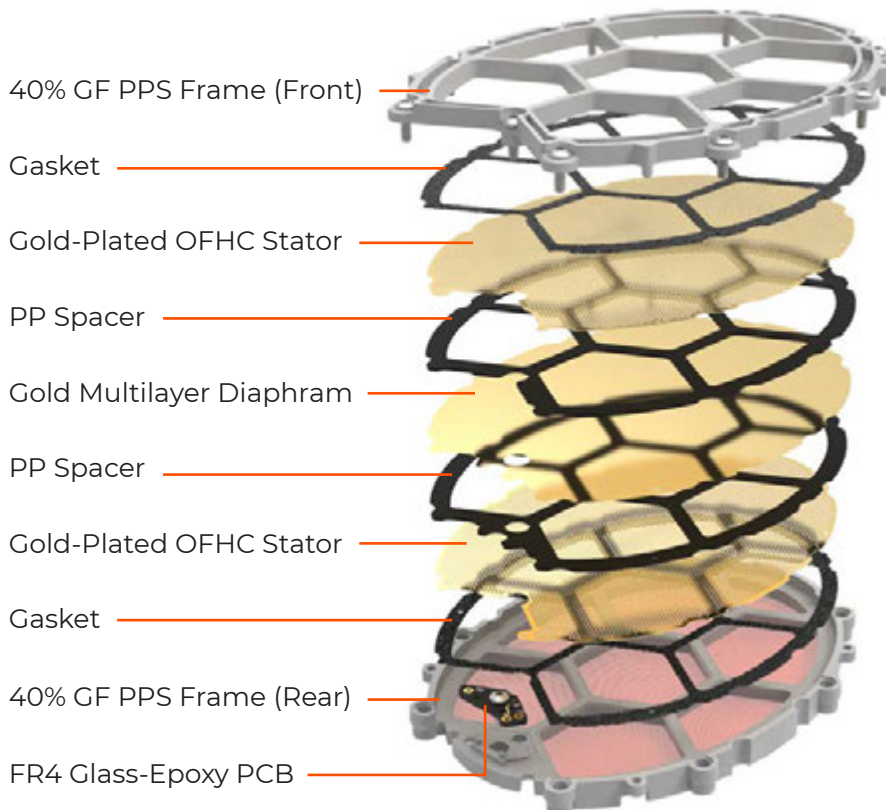

**BD-HPEL Construction (Simplified)**

The BD-HPEL diaphragm is an innovative composite design comprised of two layers of 7 µm Bi-axially Oriented Polypropylene (BOPP) film. BOPP film has the optimum properties for our BD-HPEL diaphragm: a low and stable dielectric constant, a very low dissipation factor, high breakdown strength, and very low hygroscopy (< 0.1% water absorption). Encapsulated between the films is a vapour-deposited conductive layer of 24 Kt. Gold. Acrylic-based bonding agents within the lamination have high internal damping properties that act to further suppress resonances in the film assembly. The overall diaphragm assembly is extremely thin - less than one fourth (¼) the thickness of a human hair, and consequently very low mass. The diaphragm is custom-fabricated in Germany and Austria to our exact requirements, then laser-cut at our R&D facility. The diaphragm design is inherently impervious to moisture, and resists arcing at voltages much higher than used in operation. The BD-HPEL diaphragm is charged via an 1800 V<sub>DC</sub> bias to generate the required electrical field strength. The design is carefully optimised to decrease high voltage leakage currents that could compromise and degrade performance, to less than 0.08 µA.

The diaphragm is centred between two thin, high-precision electrical stators using laser-cut Polypropylene spacers. Each stator is formed by photo-chemical etching of OFHC copper, which is subsequently gold-plated. This is the finest grade of copper available, refined to reduce the level of oxygen and other impurities to less than 0.001%.

Electrical contacts are made through a gold-plated copper, FR-4 glass epoxy PCB, which includes a novel circuit to safeguard against electrical shock.

The entire assembly is built into a high-precision frame fabricated from 40% Glass-Filled Polyphenylene Sulfide (PPS), a highly stable, ultra-rigid and inert Engineering polymer. This frame ensures that the assembled transducer is held completely flat and is invulnerable to warpage or bending.



The BD-HPEL has been designed using advanced Multi-Physics FEA (Finite Element Analysis) modelling to fully optimise electrical, mechanical and acoustical parameters.

Our goals for the BD-HPEL included minimisation of all resonant phenomena – both acoustical and mechanical, minimisation of acoustical diffraction and reflection, and optimising the “open air” acoustical properties. The resultant design ensures that acoustical loading conditions on both sides of the diaphragm are identical and that acoustic impedance is optimal (this is especially critical for low mass diaphragms).

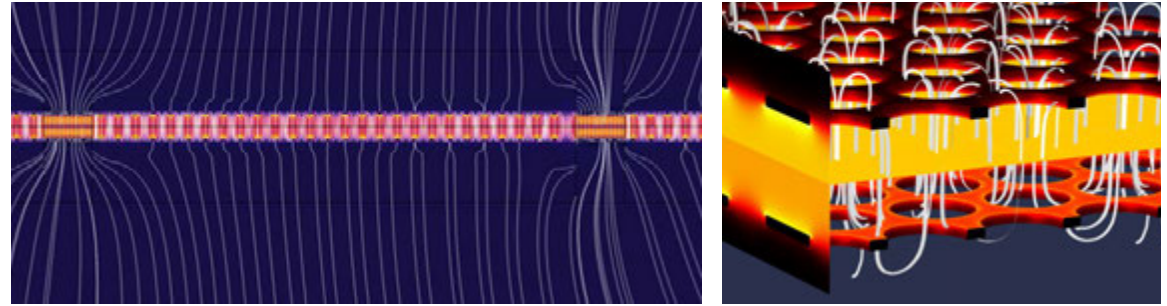

**Multi-Physics FEA Modelling of BD-HPEL Electrical Flux Distribution:  
2-D Cross-Section and 3-D Model**

Multi-Physics FEA modelling also was employed in the design to maximise electrical field strength while linearising electrical flux distribution and optimising symmetry (thus maximising the transducer’s sensitivity and reducing distortion to a minimum). Unlike conventional electrodynamic and planar magnetic transducers, the BD-HPEL is completely free from relatively large, heavy magnets and their associated non-linear magnetic field variances and hysteresis distortion effects.

A significant, performance-enhancing innovation in Warwick Acoustics’ HPEL assembly process is the automated, high-precision film tensioning system. This process allows the film tension to be very precisely controlled, to within a fraction of a Newton, and differentially equalised in all axes across the film surface. This degree of control, precision and uniformity is impossible with hand-production techniques, and results in unprecedented unit-to-unit transducer consistency.

One of the virtues of the BD-HPEL is its extremely low moving mass – a fraction of conventional electrodynamic and planar magnetic transducers. This attribute, along with the near-elimination of resonant phenomena, enables the transducer to extend its high frequency cutoff to over 60 kHz. More notably, the amplitude response is extraordinarily smooth and linear, without high frequency break-up modes, resulting in ideal transient behaviour (fast rise time and smooth, controlled decay). This is crucially significant and relevant as musical content is essentially time-variant and transient in nature. Equally important is the reduction of acoustical anomalies and distortion, which can corrupt or mask information. These are reduced to very low levels, typically well below 0.5% at maximum output.



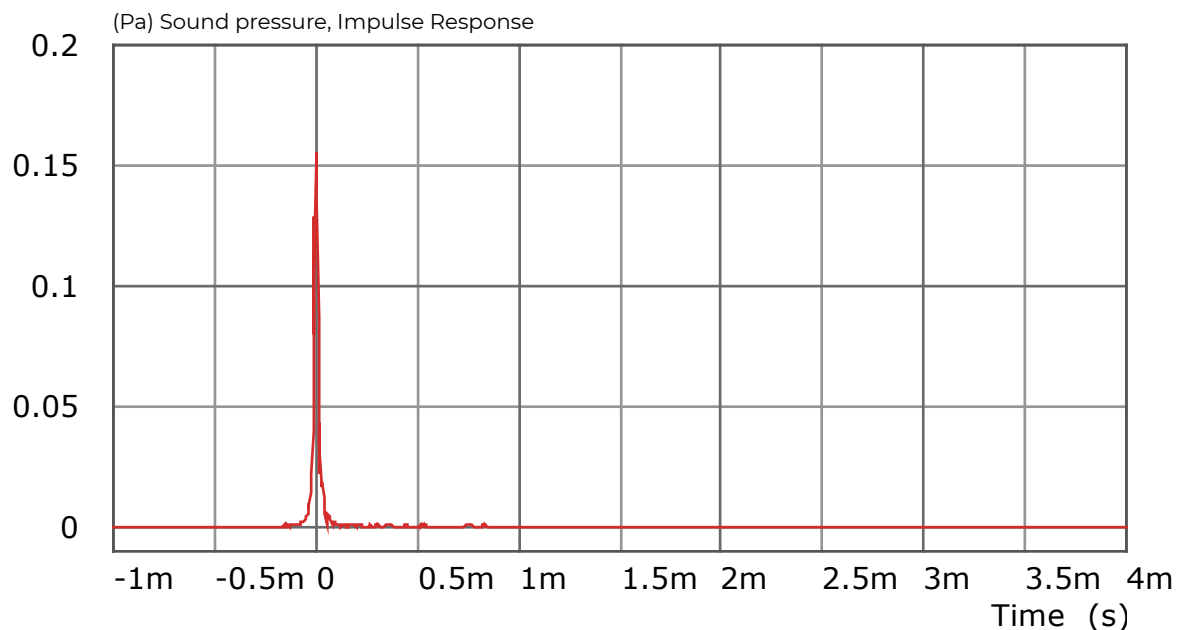

**BD-HPEL Impulse Response, Measured at 1 Metre, On-Axis**

In conventional transducers current flowing from an amplifier can heat a drive coil over time, causing significant changes in acoustical performance, including shifts in amplitude response, power compression effects and reduced long-term reliability. The BD-HPEL is free from all of these negative effects.

Development of the BD-HPEL was a comprehensive, Engineering-intensive, two-year effort, with the objective of “raising the bar” for acoustical performance to the highest level possible for a full-range, headphone transducer. But for the Warwick Acoustics Engineering team, this was a crucial and necessary prerequisite for development of the APERIO. For we believe that the transducer is the true “heart and soul” of a sound reproduction system.

The BD-HPEL has been developed for optimum frequency domain and time domain performance simultaneously, since both are requisites for achieving the highest degree of acoustical fidelity.

Our Multi-Physics modelling has enabled comprehensive non-linear time domain analyses, including examination of all forms of distortion (e.g., harmonic, intermodulation and transient intermodulation) and key time domain behaviour, such as impulse response and spectral decay.

BD-HPEL transducers have the additional benefit of eliminating inductive coil drive systems (these are required in all electrodynamic and planar magnetic transducers). Besides the obvious reduction in moving mass and elimination of high frequency attenuation from inductive loading, our transducers require virtually no current at lower frequencies.



R



# HEADPHONE TECHNOLOGY OVERVIEW

---



For the APERIO headphone, Warwick Acoustics had two primary design objectives: 1) the headphone must provide the optimum mechanical and acoustical conditions for the BD-HPEL transducer that enable the best audio performance and sound quality possible to be achieved and, 2) the headphone must be comfortable for the user, even under critical monitoring conditions, for extended periods of time.

Many of the design requirements mirror those of the BD-HPEL transducer. Minimisation of resonant phenomena was paramount, as mechanical resonances and acoustical standing waves could potentially degrade the acoustic output of the transducer. Major structural components of the headphone, for example, the ear cups, are fabricated of injected Magnesium – a rigid material lighter and significantly better-damped than aluminium and most polymers. Because the Magnesium is injected, complex and precise components that typically would require CNC-machining are possible. Key structural fasteners are fabricated from stainless steel for strength and durability. Gaskets are formed from closed-cell foams that are well-damped and free from compression-set.

The mechanical design is robust and employs the finest materials available for each functional purpose. Even the two-stage finish was selected for its excellent damping properties and durability. The result is a mechanical foundation that is extremely rigid, well-damped and free from resonances.

The development team carefully designed the ear cup components to minimise acoustical reflections and diffraction, on both sides of the transducer. Similarly, acoustic impedance is optimal on each side of the transducer. The APERIO is extremely “open” to the surrounding air, with a minimum of obstruction between the transducer diaphragm and the listener’s ear. Unlike most headphones, the APERIO does not have regions over the transducer covered with acoustical materials that impede air flow or spectrally filter the sound (aka, passive equalisation). This common approach is not needed for the APERIO and has deleterious effects on sound quality, especially with regard to detail, resolution and sonic neutrality.



In order to achieve outstanding low frequency performance, the APERIO requires a small sealed air volume between the transducer and listener's head. The APERIO maintains this air volume and requisite air seal through key design features that eliminate air leakage, even with variations in head and ear shape.

And in order to minimise acoustical standing waves within the enclosed air volume, which in turn create resonances, the ear cushions feature acoustically-absorbent foam around their inside perimeter. The ear cushions maintain the necessary air seal to the user's head while absorbing damaging acoustical reflections within the enclosed air volume.

The ear cushions are designed to improve cooling around the user's ears via perforated top surfaces and a copper thread mesh that dissipates heat. The ear cushions are covered in the finest, natural, top grain *Cabretta* leather that is sustainably sourced.







The APERIO addresses comfort by minimising weight and optimising geometry. The advanced materials utilised in the design, such as Magnesium and Engineering polymers, result in a very low mass of 405 grams. The headband has been designed around the ideal geometry for a wide range of head sizes, with the optimum clamping force to ensure a good air seal and stability on the head, without excessive pressure that could be problematic during long listening sessions. The headband maintains this optimum clamping force over the full range of adjustability (extension of the headband and ear cup position).

Because high voltages are required for operation, the APERIO is designed with a high degree of electrical isolation and multiple safety features. The BD-HPEL transducer is electrically isolated from the conductive Magnesium components. The headphone body is electrically grounded and features double-insulated electrical connections; internal wiring is insulated with High Voltage Silicone and Teflon. High performance, polarised, self-latching, stainless steel connectors with gold-plated copper, multipole contacts are utilised for electrical connection to the headphone cable.



The APERIO headphone cable is a state-of-the-art, custom design, optimised specifically for the APERIO headphone and drive electronics. The headphone cable must transmit multiple balanced analogue drive signals at up to  $500 V_{peak}$ , nearly  $2000 V_{DC}$  bias and Earth Ground - all without corruption, interference or risk of electrical shock. Because the electrical load (impedance) of the headphone is primarily capacitive, it is essential for the headphone cable to have extremely low self-capacitance, to avoid excessive current shunting at high frequencies and to minimise antenna-like EMI/RFI emissions.

The APERIO headphone cable exhibits less than  $175 \text{ pF}$  of capacitance at two meters length. Because the BD-HPEL transducers have no drive coils there is no appreciable inductance; thus, cable inductance is not a critical limiting factor of the APERIO's performance, as it could be for conventional electrodynamic and planar magnetic headphones. Similarly, resistance is much less of a factor for the APERIO, since current draw at low frequencies - where most of the musical energy resides - is negligible.

The APERIO headphone cable features a Dual Mono design with optimised conductor winding geometry and isolated shielding to minimise electrical crosstalk between channels. The electrical shielding is unique - a copper-plated Aramid fibre braid that provides excellent EMI/RFI shielding while still maintaining very good flexibility and light weight. This shielding prevents both EMI/RFI emission (pollution) and EMI/RFI absorption (which could corrupt the audio signal).

The internal wiring is formed from 66 strands of micro-fine OFHC copper per conductor, each plated in pure Silver. The wiring insulation is low durometer, High Voltage Silicone. The internal construction geometry and specialised insulation ensure that damaging high voltage leakage currents are reduced to less than 0.08 uA and that capacitance is minimised between all conductors, including to the shield. Additionally, the micro-fine conductors and Silicone insulation result in a very flexible cable design, despite the high number of internal wires.

The APERIO headphone cable includes internal *Kevlar* (Aramid polymer) damping/reinforcement fibres to dramatically reduce microphonic sensitivity and to ensure high tensile strength and durability. The cable assembly is wrapped in an ultra-thin Teflon (PTFE) barrier layer and multifilament *Nylon* and Polypropylene woven fibre jackets for additional durability and a soft texture. The cable utilises only non-hygroscopic materials to reduce moisture absorption to an absolute minimum and stabilise performance in any environment. High performance, polarised, self-latching, stainless steel connectors with gold-plated copper, multipole contacts ensure high quality, reliable electrical connections to the drive electronics and headphone.

The APERIO headphone cable provides the optimum electrical conduit between bias and amplification circuitry and the BD-HPEL transducer within the headphone. Furthermore, the cable is fully shielded from EMI/RFI, exhibits very low electrical crosstalk and microphonic sensitivity, and remains lightweight, flexible and soft to the touch without compromising durability or reliability.

The APERIO headphone is produced in the United Kingdom, at Warwick Acoustics' state-of-the-art R&D facility, and is assembled under strict laboratory conditions using cell-based production techniques. As with the BD-HPEL, we control all aspects of sourcing, production, testing and quality assurance. Every headphone produced is measured in our lab to verify acoustical performance. Individual measurements and test results are provided with each headphone.

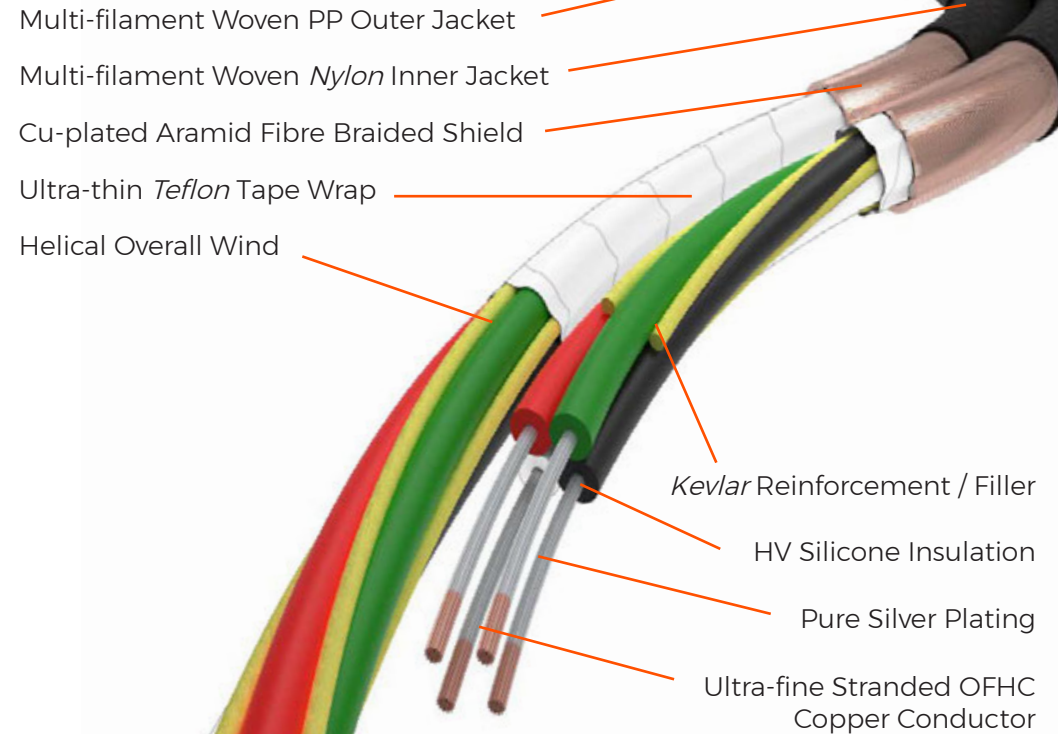

Headphone Cable Construction (Simplified)





# ELECTRONICS TECHNOLOGY OVERVIEW

---



Because the APERIO is a complete sound reproduction system, the electronics are optimised specifically for the APERIO headphone. Every element of the sound reproduction chain between raw audio data input (from an analogue or digital source) and output to the headphone is included and fully optimised within the APERIO electronics.

Every functional sub-section of the electronics has been designed to state-of-the-art standards, without compromise. And as a complete system, each section works together seamlessly and synergistically to achieve audio performance superior to individual components, especially within the context of driving the APERIO headphone.

The APERIO electronics comprise the following audio functions: full-feature preamplifier with line output, digital-to-analogue converter (DAC) and headphone amplifier, including bias voltage “energiser”. The APERIO preamplifier function includes a wide range of inputs: balanced and unbalanced analogue, AES3 (AES/EBU), S/PDIF Coaxial, USB and Ethernet (LAN). The analogue inputs feature independently switchable gain and differential buffer circuitry to maximise audio performance for analogue signals ranging from low-level consumer audio (< 1.0 V<sub>rms</sub>) to high-level professional audio (up to 18 dBu). Digital inputs feature state-of-the-art PLL input circuitry and asynchronous clocking for USB and Ethernet sources.

Within the APERIO electronics, all analogue circuitry and PCB routing is differential (balanced), with gain levels carefully optimised between all stages to maximise Signal-to-Noise Ratio (SNR). The topology is as simple as possible to minimise the number of stages and devices that the audio signal must pass through. All audio routing and switching is performed using the finest signal relays, with gold-plated silver contacts.

The audio signal is not routed through internal cables and never passes through panel switches or potentiometers. All circuitry in the APERIO electronics, including power supply regulation, employs a Dual Mono topology to minimise crosstalk and interference between channels.

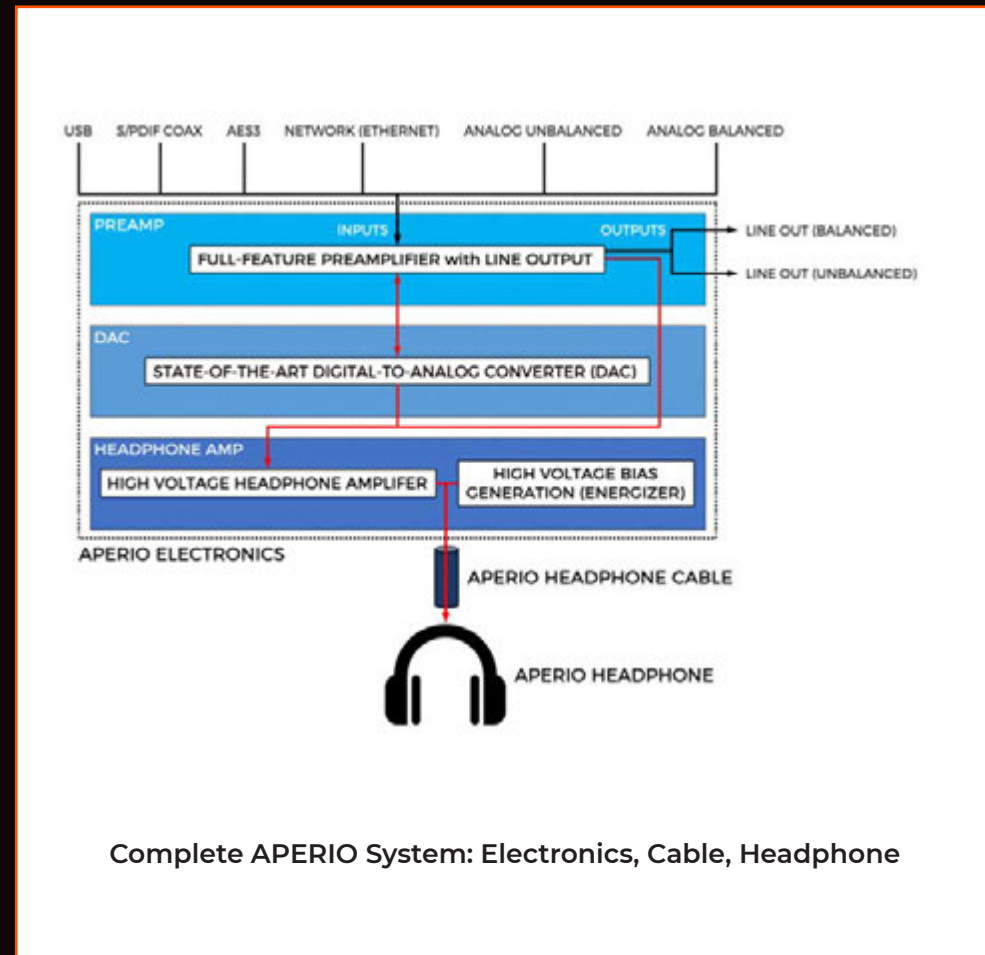

Complete APERIO System: Electronics, Cable, Headphone

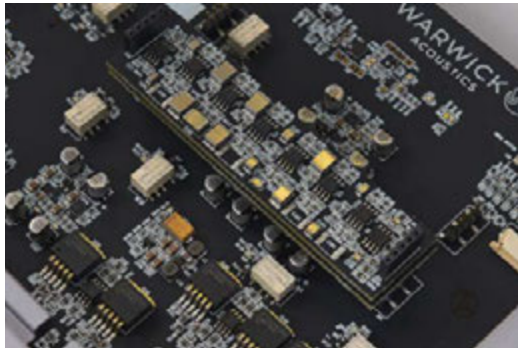

Only the finest active and passive components are utilised in the APERIO circuitry. Cutting-edge ICs and high voltage discrete transistors are selected and applied in circuitry based upon best audio performance and sound quality achieved. The highest quality 0.5% tolerance metal film resistors and 2% tolerance polymer film capacitors are utilised in critical circuitry.



The analogue Line Output section features a novel Class A circuit that can output very high voltages with prodigious current, allowing it to effortlessly drive outboard electronics in any professional or consumer application, even with extremely long cables.

We've tested the Line Output section with 150-meter-long balanced cables driven to 15 dBu (12.3 V<sub>p-p</sub>) without distortion.

Clocking circuitry for digital inputs and DACs is designed for ultra-low jitter and phase noise: typical phase jitter is 82 fSec RMS at 100 MHz; close-in phase noise is -90 dBc/Hz @ 10 Hz with a noise floor of -168 dBc/Hz. The sophisticated clocking system in the APERIO is one of the costliest sections in the electronics.

Ethernet (LAN) inputs are buffered by a separate Linux-based subsystem within the APERIO in order to surpass the typical DLNA (Digital Living Network Alliance) limitations and enable digital audio reproduction of native or DoP 256 f<sub>s</sub> DSD and higher sample rate PCM formats to 384 kHz. Furthermore, digital data is asynchronously clocked in the same manner as USB inputs, to minimise jitter.

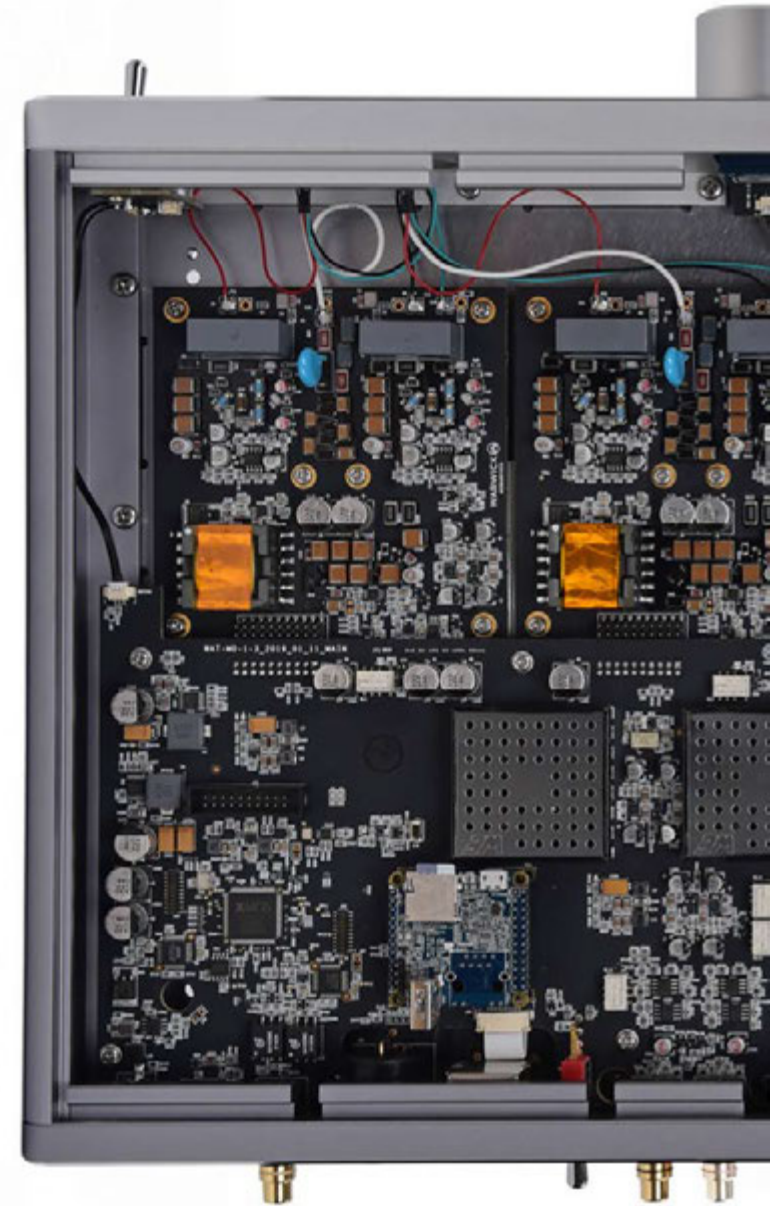



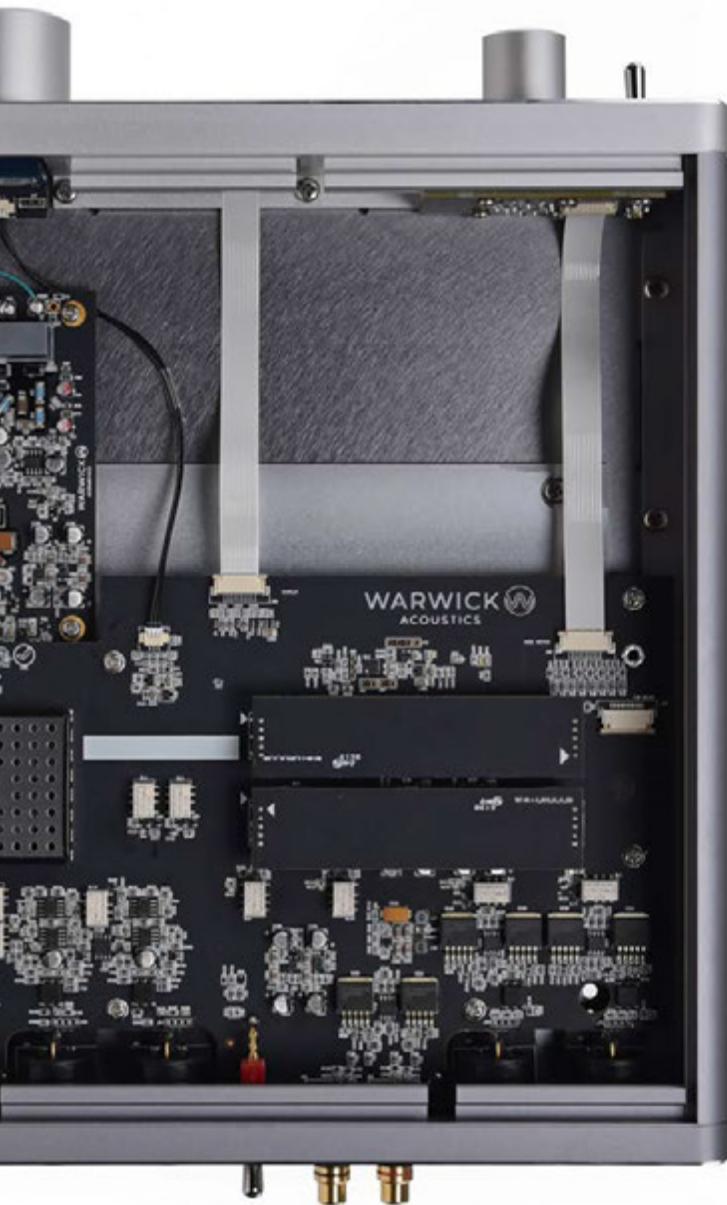

All digital data is kept in its native format before being converted to analogue in the APERIO's DAC section. Any DSP performed (on PCM data) is double-precision, 64-bit, fixed-point, at native sample rates - equal to the best professional Digital Audio Workstations (DAWs). Within the APERIO DSD data is not converted to PCM; and, analogue data is not converted to digital data.

The DAC section of the APERIO electronics is truly state-of-the-art. Dual 32-bit, 8-channel DACs are utilised - one per channel in dual mono configuration, to achieve a SNR of 131 dB. Each channel's DAC section is housed within separate EMI shields ("cans") and supplied by isolated, local, ultra-low-noise power regulators.

The APERIO features a very unique level control (volume adjustment) configuration to preserve audio quality.

Dual domain level controls are implemented - an analogue attenuator for analogue and DSD signals, and a digital attenuator for PCM digital signals. The analogue attenuator is based on parallel, laser-trimmed resistance ladder networks and is fully differential. The digital attenuator is DSP-based with optimal re-quantisation and dithering to eliminate "zipper noise" and other anomalies. Both attenuators are calibrated and matched.

The APERIO's headphone amplifier section is fully optimised for driving the APERIO headphone. It supplies a pristine, ultra-low-noise DC bias voltage of 1800 V for "energising" or charging the BD-HPEL transducers. The headphone section also amplifies the analogue audio signal to properly drive the transducers; maximum output is 495 V<sub>peak</sub> (175 V<sub>rms</sub>). Output amplification is a proprietary topology based on Single-Ended Class A operation.

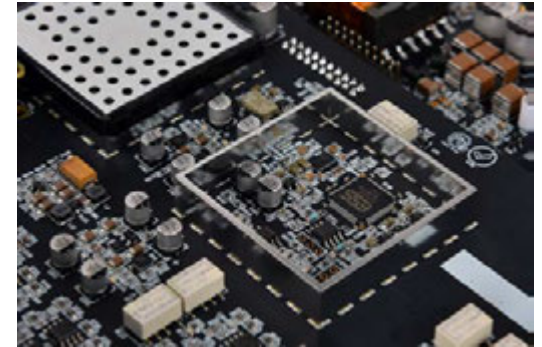



**Output Devices: 8 x 1000 MOSFETs/Channel**

Eight (8) discrete, 1000 V, depletion-mode MOSFETs are used per channel, in a fully balanced configuration. This is not a “push-pull” amplifier in the traditional sense, as each half of the drive circuit is identical and operated in Single-Ended Class A. These output circuits are biased very richly and are capable of delivering approximately 15 watts of power per channel. The result is extraordinary dynamic headroom and linearity, with typical THD+N (A-weighted) measurements of 0.001% at 250  $V_{peak}$  (500  $V_{p-p}$  differential).

Each channel is fed by a dedicated high voltage power supply capable of delivering 50 W of DC power. Each channel’s power supply, bias generation and amplification circuitry are housed on separate mono PCBs for complete channel isolation.

Class A analogue circuitry, sensitive DAC and clocking circuitry and other specialised ICs require very stable, highly isolated and ultra-low-noise DC power, with sufficient current, to function at their highest level of performance. To ensure this, the APERIO features a high-current power supply designed without compromise. The power supply can output more than twice the typical DC power (current) required in normal operation, for > 3 dB of headroom. Supplied DC power is isolated and separated for analogue and digital circuitry as well as left and right channels.

Three stages of sequential power regulation are utilised. A 200 VA (watt) outboard switch-mode power supply (SMPS) keeps high-level switching circuitry far from sensitive internal circuitry. The SMPS was designed specifically for audio use, with a fixed switching frequency outside the audio bandwidth. The noise spectrum within the audio band is exceptionally low in level and uncorrelated to audio signals. A second stage of voltage regulation is used internally for isolation and separation. The final stage of voltage regulation is performed locally, as close as possible to the supplied circuitry, and is exclusively ultra-low-noise, linear regulation. The resultant DC voltage rails are precise, stable and completely free from interference, noise and other perturbances that could degrade audio quality.

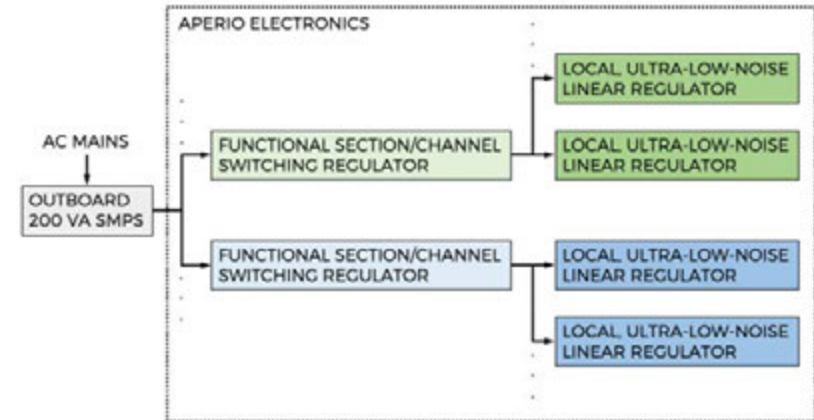

**Three-Stage Power Regulation Scheme (Simplified)**



All PCBs within the APERIO electronics are FR-4 Glass Epoxy with 2 oz. (2.8 mil or 70  $\mu\text{m}$ ) copper – this is double the typical copper thickness. The extra copper provides two major benefits: significantly lower impedance ground planes improve SNR performance; and, twice the heat transfer is provided from active devices to heat sinks. Additionally, all PCBs are six-layer designs, allowing separation and isolation of analogue and digital traces, power supply rails and ground planes.

Because the APERIO is designed for the highest possible level of audio performance, and features balanced, high-bias, single-ended Class A circuitry throughout, a relatively large amount of heat is generated, even during idle conditions. Significant engineering was required to properly dissipate this heat without affecting audio quality. The APERIO's case is CNC-machined from 30 mm thick 6063 Aluminium, which acts as an ideal heat sink (the amplification output transistors are bonded directly to the case). Extensive flow-through ventilation is provided as well.

Four ultra-quiet fans assist in air-cooling, when temperatures exceed 45° C. These fans – the quietest available – are mechanically decoupled from the electronics enclosure and PWM-controlled. The fan speed is adjusted by the APERIO's internal processor based on the measured temperature of the amplification output devices. In 90% of usage cases, the fans will be turned off; it is only during extensive listening sessions, most likely in studio conditions, or very hot environments, that the fans will be active. However, even when active, the fans are not audible while listening to headphones.

An additional benefit of the APERIO's massive aluminium chassis is highly effective shielding. Every section of the case is electrically bonded together, creating an ideal EMI/RFI shield. Sensitive internal circuitry is protected from external EMI/RFI corruption, and emissions from the APERIO are fully contained. Furthermore, the shielding is electrically connected to the headphone cable and headphone body, creating a fully-shielded system, from input to output.

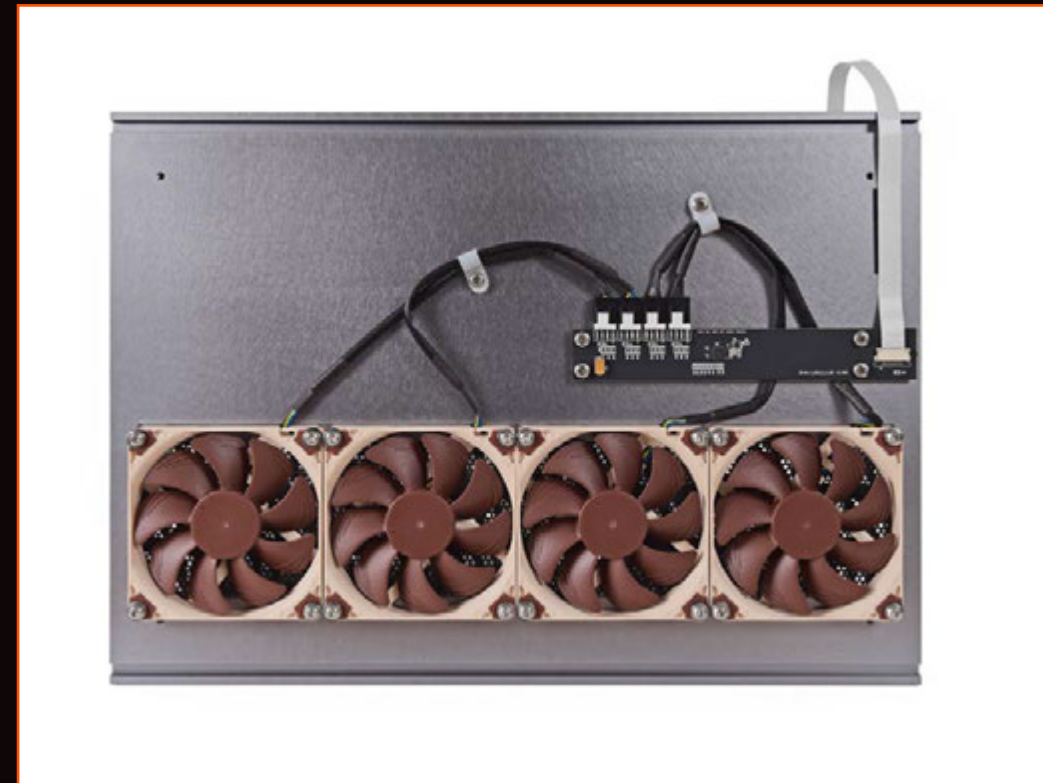



The APERIO electronics have been designed to minimise mechanical resonances and the transmission of vibrational energy that could modulate low level audio signals in sensitive circuitry. The aluminium chassis sections interlock and are fastened together using stainless steel hardware with thread-locking compounds (to prevent loosening and vibration over time). The complete assembly rests on specialised mounting feet, formed of a highly-damped thermoplastic compound (IsoDamp C-1002), that isolate the enclosure from external shock and vibration. Internal PCBs also are very well damped due to the glass-epoxy substrate and double-thickness copper.

Warwick Acoustics supplies two high performance input cables with the APERIO: a USB 2.0 Type A to B cable, and an Ethernet cable. These cables are custom designs, developed by Warwick Acoustics to match the performance and quality level of the rest of the APERIO system. Both cables utilise superior SF/FTP construction, with double overall shielding (aluminium-mylar foil and copper-plated Aramid fibre braiding) as well as internal shielding of each of the double-helix twisted pair conductors. All internal data wiring is formed from 66 strands of micro-fine OFHC copper per conductor, each plated in pure Silver. The wiring insulation is high-grade Polyethylene (PE), with a very low dielectric constant (< 2.0). The outer jackets are formed from low durometer Thermoplastic Elastomer (TPE) covered with a multifilament woven Polypropylene braid for durability and a soft texture.

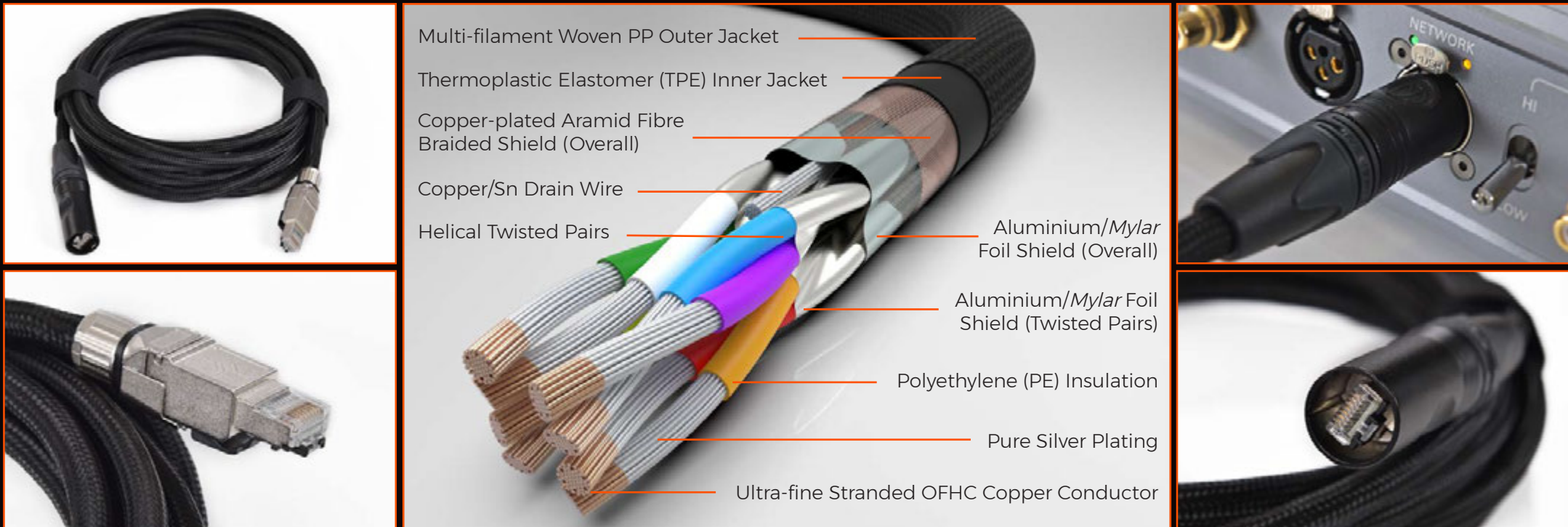

**Ethernet Cable Construction (Simplified)**



Multi-filament Woven PP Outer Jacket

Thermoplastic Elastomer (TPE) Inner Jacket

Copper-plated Aramid Fibre Braided Shield (Overall)

Copper/Sn Drain Wire

Aluminium/Mylar Foil Shield (Overall)

Helical Twisted Pairs

Aluminium/Mylar Foil Shield (Twisted Pairs)

Polyethylene (PE) Insulation

Pure Silver Plating

Ultra-fine Stranded OFHC Copper Conductor



### USB Cable Construction (Simplified)

The USB cable connectors are high-quality, gold-plated Type A and B plugs. The USB cable is designed to be impervious to noise, interference and emissions while maintaining an optimal  $90 \Omega$  characteristic impedance over the full operating bandwidth; it is fully compliant with USB 2.0 standards. The Ethernet cable connectors are the finest quality, ruggedised plugs available: professional, full-metal shielded XLR (RJ45) type from *Neutrik* and universal, full-metal shielded RJ45 type from *Telegärtner*. The Ethernet cable also is designed to be impervious to noise, interference and emissions and maintains an optimal  $100 \Omega$  characteristic impedance over the full operating bandwidth. While the connectors are certified as CAT6A type, the cable is compliant with CAT7 standards.

The APERIO electronics are assembled in the Bay Area of California, USA, by skilled technicians using cell-based production techniques. All units are fully tested and measured to verify audio performance after assembly, with individual test results provided for every unit produced.

# CONCLUDING WORDS

---

The Warwick Acoustics APERIO is designed without compromise to set new standards in sound reproduction, and to redefine the level of audio performance achievable in a headphone system. The APERIO is hand-crafted in very limited quantities, assuring the highest degree of performance and quality.

The heritage of Warwick Acoustics Engineering and development team has its genesis in high performance professional audio, specifically developing tools required for the production of High Resolution Audio recordings. Just as premium automotive brands draw upon their experience and cutting-edge technologies from competitive racing programs, Warwick Acoustics leverages decades of professional audio development - from a team responsible for some of the most advanced and innovative gear produced for the music industry.

The APERIO is a distillation of the collective passion, expertise and experience of the Warwick Acoustics development team and represents our vision of advanced technology in the service of art. It is our hope that everyone fortunate enough to listen through the APERIO will experience what we intended - whether in the creative process of producing music or in the enjoyment of hearing music re-created.



APERIO  
WARWICK ACOUSTICS 



# SPECIFICATION

## ELECTRONICS SPECIFICATIONS:

Balanced Analog Inputs	Dual (female) XLR jacks; switchable (high / low) input range; 18 dBu / 10 dBu
Unbalanced Analog Inputs	Dual RCA jacks; switchable (high / low) input range; 5.0 V <sub>rms</sub> / 2.1 V <sub>rms</sub>
USB Digital Input	Type B jack; USB 2.0; accepts digital audio formats up to 32-bit / 384 kHz PCM and DSD (DSD64/DSD128/DSD256) via DoP or Native
Network (Ethernet LAN) Digital Input	RJ45 jack; DLNA-compatible; accepts digital audio formats up to 32-bit / 384 kHz PCM and DSD (DSD64/DSD128/DSD256) via DoP or Native
AES3 (AES/EBU) Digital Input	XLR (female) jack; accepts digital audio formats up to 24-bit/192 kHz PCM
S/PDIF Coaxial Digital Input	RCA jack; accepts digital audio formats up to 24-bit/192 kHz PCM
Line Outputs	Balanced and unbalanced, high current outputs; +5 dB gain; switchable
Digital Formats	PCM: 16-32 bit / up to 384 kHz; DSD: up to 256 f <sub>s</sub> DoP and Native
Digital Signal Processing (DSP)	64-bit (double-precision) fixed-point processing at native sample rates
Switchable Gain	Rear panel switch; high level / low level selection for balanced analog input (professional audio and consumer levels) and unbalance analog input
Source Selection	Multi-position front panel selector with indicator LEDs for all sources
Level Control	Front panel, 31-position; digital & analog domain volume control (HP & Line Out)
Status Display	Front panel, 51 mm, full color, QVGA, TFT LCD (240 x 320 pixels)
Display Functions	Digital readout and bar graph of volume control setting; display of digital audio data format; display of rear panel analog input (gain) settings; display of Ethernet and USB data link transmission lock; display of detected fault modes and output clipping
Auto Fault Detection	Automatic detection, display and protection for: output amplifier clipping, unplugged connections and malfunctioning wiring, over-temperature conditions and internal electrical faults
DACs	2 x dual mono, 32-bit / 384 kHz DACs; balanced outputs, for PCM & DSD inputs
Amplifier/Energizer	Balanced, discrete MOSFET, high-bias, single-ended Class A output; dual mono topology, including power supply; 1800 V <sub>DC</sub> bias (charge) voltage
Distortion + Noise	< 0.001%
Bandwidth	> 65 kHz
Enclosure	CNC-machined 6063 aluminum; earth-grounded
Power Supply	External: world voltage compatible (90-264 Volt AC, 50-60 Hz); 24 Volt DC, 200 VA (8.333 A), fixed frequency, class B-compliant SMPS; Internal: isolated, dual mono; switching and ultra-low-noise linear regulation
AC Mains	Types B, C, F, I; IEC-60320 C14, earth-grounded power cable; 1.5 meter length
Dimensions	H x W x D: 68 mm (2.68 in.) x 413 mm (16.26 in.) x 351 mm (13.82 in.)
Weight	7.4 kg (16.28 lbs.), without Power Supply

## HEADPHONE SPECIFICATIONS:

Configuration	Open-back; circumaural type
Transducer	Balanced-Drive High Precision Electrostatic Laminate (BD-HPEL)
Effective Diaphragm Area	3570 mm <sup>2</sup>
Frequency Response	10 Hz - 60 kHz
Output Level (SPL)	Compliant with EN 60065/A12:2011 (EN50332) when driven by APERIO electronics (for all inputs); digital input: ~ 104 dB; analog input: ≥ 106 dB (continuous, est.)
Ear and Headband Cushions	"Cabretta" top-grain, sheepskin leather; perforated surface on ear cushions
Input	Polarized, 4-pin, self-latching connectors for left and right channels
Drive Cable	Dual mono, shielded, ultra-low capacitance; silver-plated OFHC ultra-fine stranded copper, silicone insulation and Kevlar reinforcement; 2 meter length
Weight	405 grams (14.3 oz.), without cable



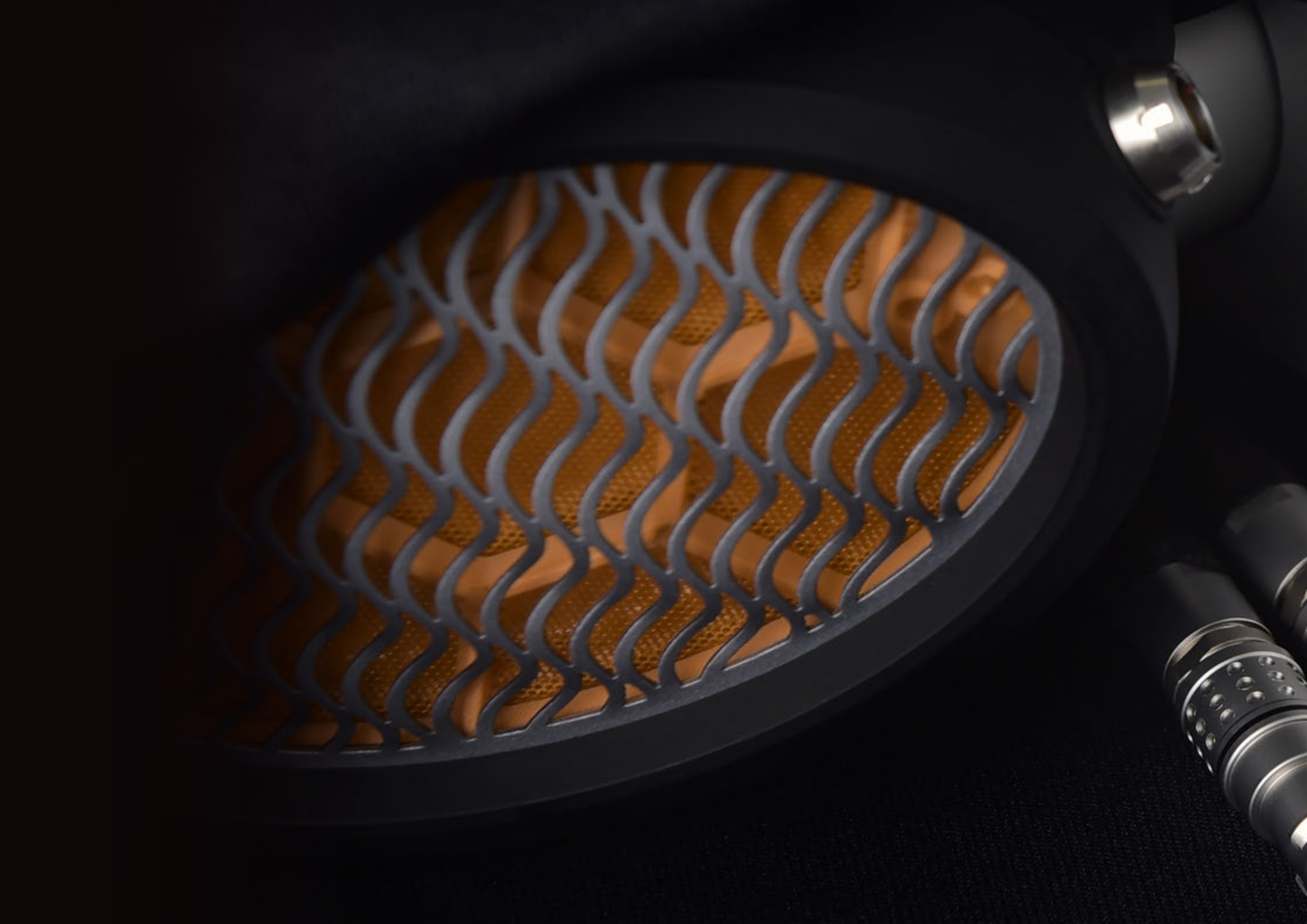





WARWICK  
ACOUSTICS  
APERIO

HP OUTPUT



L







APERIO  
WARWICK ACOUSTICS 

AT WARWICK ACOUSTICS,  
WE CREATE GROUND-BREAKING  
AUDIO PRODUCTS DESIGNED WITH A  
SINGLE-MINDED MISSION;

*TO DELIVER TRULY REMARKABLE  
LISTENING EXPERIENCES*